

FM Stereo/FM-AM Receiver

Operating Instructions

STR-D990
STR-D790

Warning

WARNING

To prevent fire or shock hazard, do not expose the unit to rain or moisture.



CAUTION
RISK OF ELECTRIC SHOCK
DO NOT OPEN



CAUTION: TO REDUCE THE RISK OF ELECTRIC SHOCK,
DO NOT REMOVE COVER (OR BACK).
NO USER-SERVICEABLE PARTS INSIDE.
REFER SERVICING TO QUALIFIED SERVICE PERSONNEL.



This symbol is intended to alert the user to the presence of uninsulated "dangerous voltage" within the product's enclosure that may be of sufficient magnitude to constitute a risk of electric shock to persons.



This symbol is intended to alert the user to the presence of important operating and maintenance (servicing) instructions in the literature accompanying the appliance.

Owner's Record

The model number is located on the rear exterior and serial number is on the rear. Record the serial number in the space provided below. Refer to these numbers whenever you call upon your Sony dealer regarding this product.

Model No. _____ Serial No. _____

Note to CATV system installer

This reminder is provided to call the CATV system installer's attention to Article 820-40 of the NEC that provides guidelines for proper grounding and, in particular, specifies that the cable ground shall be connected to the grounding system of the building, as close to the point of cable entry as practical.

This equipment generates and uses radio frequency energy and if not installed and used properly, that is, in strict accordance with the manufacturer's instructions, may cause interference to radio and television reception. It has been type tested and found to comply with the limits for a Class B computing device in accordance with the specifications in Subpart J of Part 15 of FCC Rules, which are designed to provide reasonable protection against such interference in a residential installation. However, there is no guarantee that interference will not occur in a particular installation. If this equipment does cause interference to radio or television reception, which can be determined by turning the equipment off and on, the user is encouraged to try to correct the interference by one or more of the following measures:

- Reorient the receiving antenna
- Relocate the equipment with respect to the receiver
- Move the equipment away from the receiver
- Plug the equipment into a different outlet so that equipment and receiver are on different branch circuits.

If necessary, the user should consult the dealer or an experienced radio/television technician for additional suggestions. The user may find the following booklet prepared by the Federal Communications Commission helpful:

"How to identify and Resolve Radio-TV Interference Problems". This booklet is available from the U.S. Government Printing Office, Washington, DC 20402, Stock No. 004-000-00345-4.

NOTICE FOR THE CUSTOMERS IN THE UNITED KINGDOM

IMPORTANT

The wires in this mains lead are coloured in accordance with the following code:

- Blue: Neutral
- Brown: Live

As the colours of the wires in the mains lead of this apparatus may not correspond with the coloured markings identifying the terminals in your plug-proceed as follows: The wire which is coloured blue must be connected to the terminal which is marked with the letter N or coloured black. The wire which is coloured brown must be connected to the terminal which is marked with the letter L or coloured red. Do not connect either wire to the earth terminal in the plug which is marked by the letter E or by the safety earth symbol \perp or coloured green or green-and-yellow.

For the customers in Canada

CAUTION :

TO PREVENT ELECTRIC SHOCK, DO NOT USE THIS POLARIZED AC PLUG WITH AN EXTENSION CORD, RECEPTACLE OR OTHER OUTLET UNLESS THE BLADES CAN BE FULLY INSERTED TO PREVENT BLADE EXPOSURE.

This apparatus complies with the Class B limits for radio noise emissions set out in Radio Interference Regulations.

Table of Contents

Introduction

Overview	4
Precautions	4

Chapter 1 Getting Started

Unpacking	5
Choosing a good location	5
Checking the supplied accessories	5
Selecting the AM tuning interval	5
Inserting the batteries into the remote commander	5
Hooking up the system	6
Connecting audio equipment	6
Connecting video equipment	7
Connecting an FM antenna	7
Connecting an AM antenna	7
Connecting the antenna ground	7
Connecting speaker systems	8
Connecting to the AC power outlet	9
Parts identification	10
Front panel	10
Remote commander (except for U.K. model)	12

Chapter 2 Basic Operations

Operating with the remote commander	13
Changing the settings of the FUNCTION buttons	13
Adjusting basic audio controls	14
Adjusting volume	14
Adjusting left and right sound balance	14
Adjusting tone from the front speakers	14
Reinforcing the bass	14
Selecting the speaker system	14
Selecting a program source	15
To turn off the power at the desired time (The sleep timer function)	15
Labeling the program source	16
Receiving broadcasts	17
Tuning in a station directly (Direct tuning)	17
Scanning stations automatically (Auto tuning)	18
Presetting stations (Station preset)	19
Tuning in a preset station (Preset tuning)	20
Labeling the preset stations (Station index)	21
Selecting a station among the preset stations in the index (Index tuning)	22
Receiving FM simulcast TV programs	22
Recording an audio source	23
Recording onto an audio tape deck or DAT deck	23
Tape dubbing	23
Editing a video source	24
Video tape dubbing	24
Adding new sound on a video tape during video editing	25

Chapter 3 Advanced Operations

Getting ready for Dolby surround sound	27
Placement of speakers and selecting the PRO LOGIC MODE	27
Adjusting the speaker volume	28
Adjusting the surround sound	29
Adjusting the delay time of the rear speakers	29
Sound field settings	30
Available type of effects	30
Adjusting the tone controls	31
Adjusting the sound field programs	31
Calling up the sound field setting	32
Linking the sound field memory to preset stations or program source	32

Chapter 4 Other Information

Troubleshooting guide	33
Specifications	35
Quick reference	37

Overview

The STR-D990/D790 is an FM Stereo/FM-AM receiver and audio/video control center.

You can enjoy various audio/video program sources with this unit.

TV/video programs

- You can enjoy TV or CATV programs with FM simulcast.
- Sounds from various audio program sources can be added on video tapes during editing.

Tuner

- Precise tuning is ensured by a quartz lock digital synthesizer.
- Station Index system allows you to tune into a station quickly.

DOLBY PRO LOGIC

In the DOLBY or THEATER mode, the Dolby* Pro Logic can be selected. The Dolby Pro Logic Surround Decoder has the same functions for playback as movie theaters and gives a theater-like experience in your listening room, naturally reproducing the audio sound field.

- Manufactured under license from Dolby Laboratories Licensing Corporation. Additionally licensed under one or more of the following patents: U.S. numbers 3,632,886, 3,746,792, and 3,959,590. Canadian numbers 1,004,603 and 1,037,877. "DOLBY" and the double-D symbol  are trademarks of Dolby Laboratories Licensing Corporation.

Sound field (combination of digital delayed surround and tone controls)

- 7 recommended sound field programs (DOLBY, THEATER, LIVE, HALL, DISCO, SIMULATED, ACOUSTIC) are preset in the factory for easy use. You can also store up to 7 settings you created in the memory.
- Combined use of the sound field programs and the preset stations or program source allow you to enjoy broadcast or program source listening immediately with the memorized 7 settings of sound field (DOLBY, THEATER, LIVE, HALL, DISCO, SIMULATED, ACOUSTIC).

Remote commander

- The supplied remote commander allows you to remotely control this receiver and the equipments connected to the receiver.

Precautions

On safety

- For U.K. model, operate the unit only on 240 V AC, 50/60 Hz.
- Operate the unit only on 120 V AC, 60 Hz.
- Should any solid object or liquid fall into the cabinet, unplug the unit and have it checked by qualified personnel before operating it any further.
- Unplug the unit from the wall outlet if it is not to be used for an extended period of time. To disconnect the cord, pull it out by grasping the plug. Never pull the cord itself.
- One blade of the plug is wider than the other for the purpose of safety and will fit into the power outlet only one way. If you are unable to insert the plug fully into the outlet, contact your dealer. (except for U.K. model)
- AC power cord must be changed only at the qualified service shop.
- This unit is not disconnected from the AC power source as long as it is connected to the mains outlet, even if the unit itself has been turned off.

On operation

Before making program source connections, be sure to turn the power switch off and unplug the unit.

On cleaning the cabinet

Clean the cabinet, panel and controls with a soft cloth lightly moistened with mild detergent solution. Do not use any type of abrasive pad, scouring powder, or solvent such as alcohol or benzene.

For the customers in the U.S.A.

For detailed safety precautions, see the "IMPORTANT SAFEGUARDS" leaflet.

If you have any question or problem concerning your unit, please consult your nearest Sony dealer.

Unpacking

Choosing a Good Location

To prevent internal heat buildup in the unit, place the unit in a location with adequate air circulation.

Do not install the unit:

- near heat sources such as radiators or air ducts.
- in a place subject to direct sunlight, excessive dust, mechanical vibration or shock.

Do not place anything on top of the cabinet.

The top ventilation holes must be unobstructed for the proper operation of the unit and to prolong the life of its components.

Do not throw away the carton and packing material!

It will be an ideal container when transporting the system for repair work, etc.

Checking the Supplied Accessories

After unpacking, check that the following accessories are present.

- FM wire antenna(1)
- AM loop antenna.....(1)
- Remote commander RM-U221(1)
- Sony batteries SUM-3 (NS).....(2)

Selecting the AM Tuning Interval

The AM tuning interval is preset to 10 kHz. To use the receiver where the frequency allocation system is based on a 9 kHz interval, make the following adjustments.

- 1 Turn on the power and tune in any AM station.
- 2 Turn off the power.
- 3 Press the POWER button while pressing the "+" INDEX SELECT/TUNING button.

To reset the AM tuning interval, repeat the above steps.

Caution

When the interval is changed, all preset stations which you have memorized will be erased. After changing the interval, be sure to preset the stations again.

Inserting the Batteries into the Remote Commander

Before operating remote commander, install the batteries as shown.

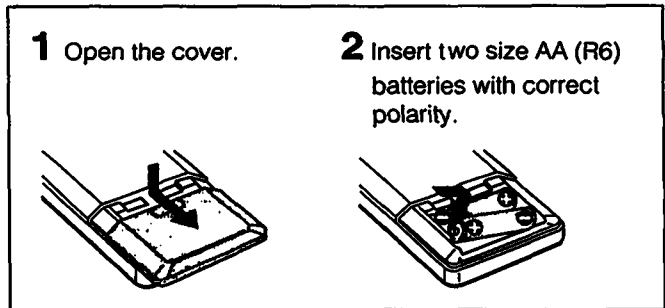

To avoid damage caused by battery leakage and corrosion

When the commander will not be used for a long time, remove the batteries.

Battery life

Normal operation can be expected about a half year using Sony SUM-3 (NS), and a year using Sony AM-3 (NW) alkaline batteries.

When the batteries are run down, the remote commander will not operate the unit. In this case, replace batteries with new ones.

Hooking Up the System

At first, this section describes about the connection with the other equipments, the antenna connection, speaker connection and then the AC power connection.

- Do not connect the power cord to an AC outlet nor press the POWER switch before accomplishing all other connections.
- The cable connectors should be fully inserted into the jacks. Loose connection may cause hum and noise.
- Jacks and plugs of the connecting cord are color-coded as follows:
Red jacks and plugs: For the right channel of audio signals
White jacks and plugs: For the left channel of audio signals
Yellow jacks and plugs: For video signals

Connecting Audio Equipment

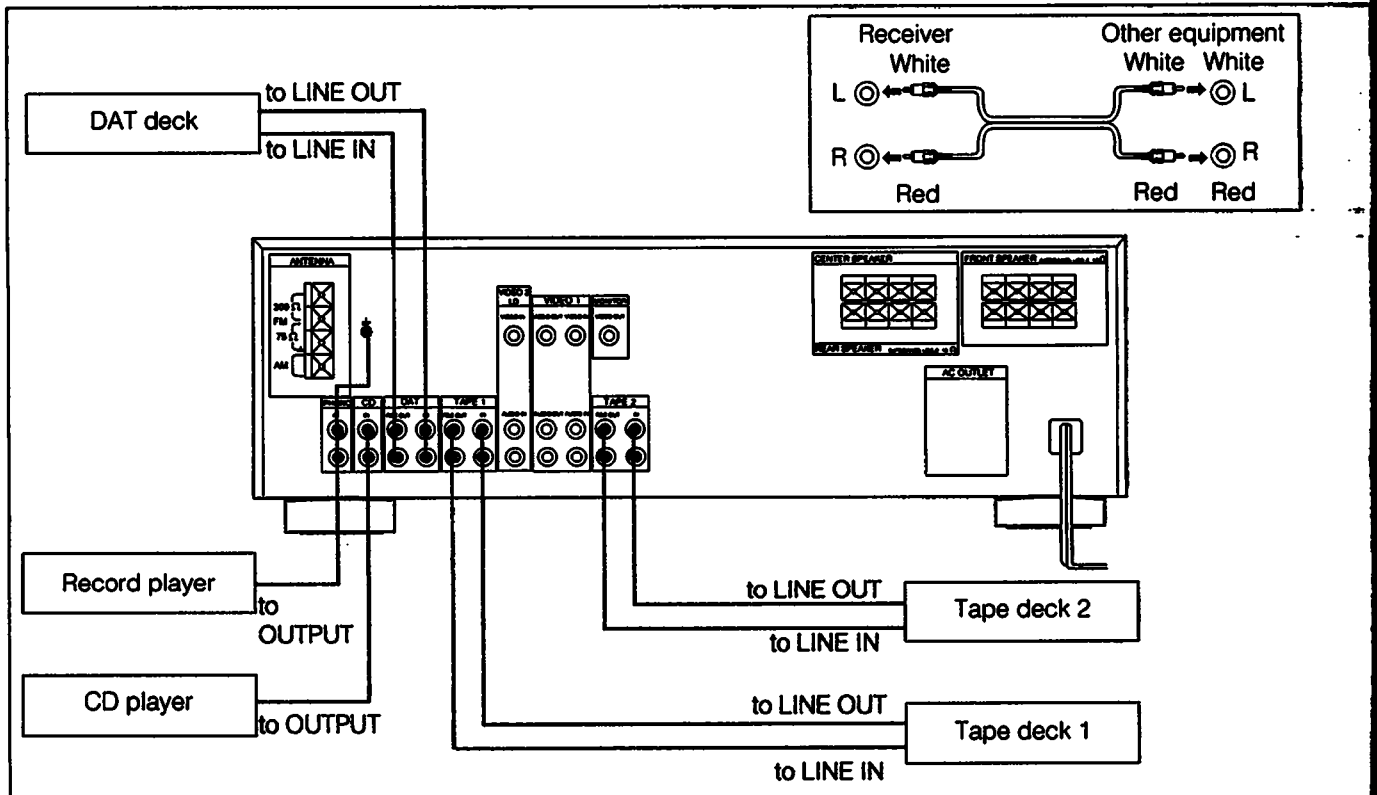

Connecting Video Equipment

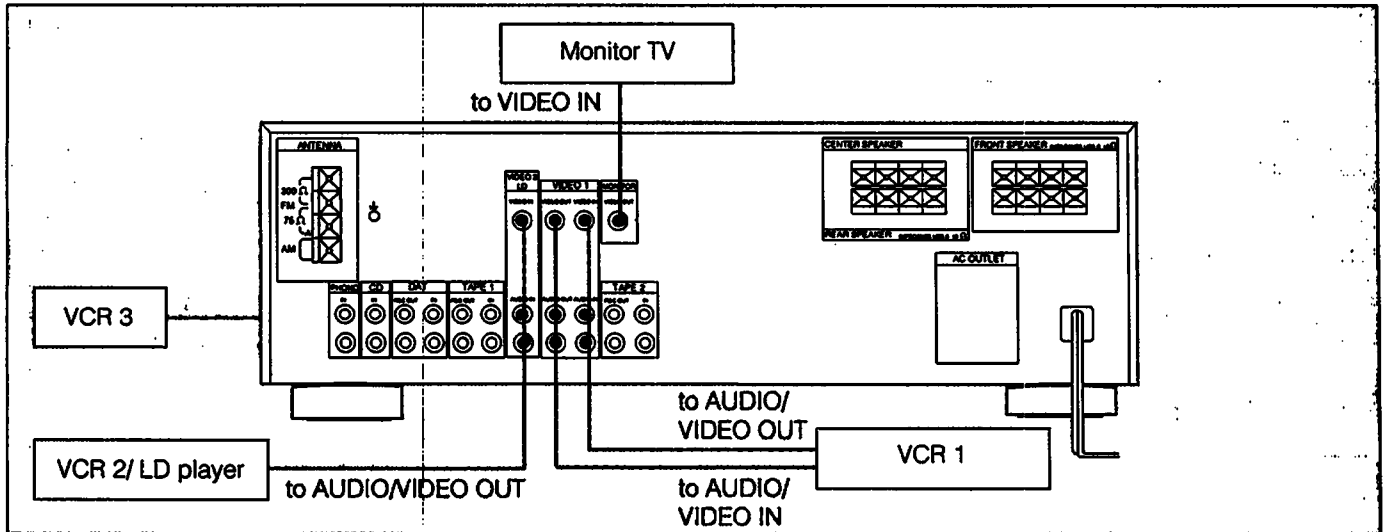

Connecting an FM Antenna

Though the ribbon antenna is supplied with this unit, the higher quality sound will be obtained with the 75-ohm coaxial cable.

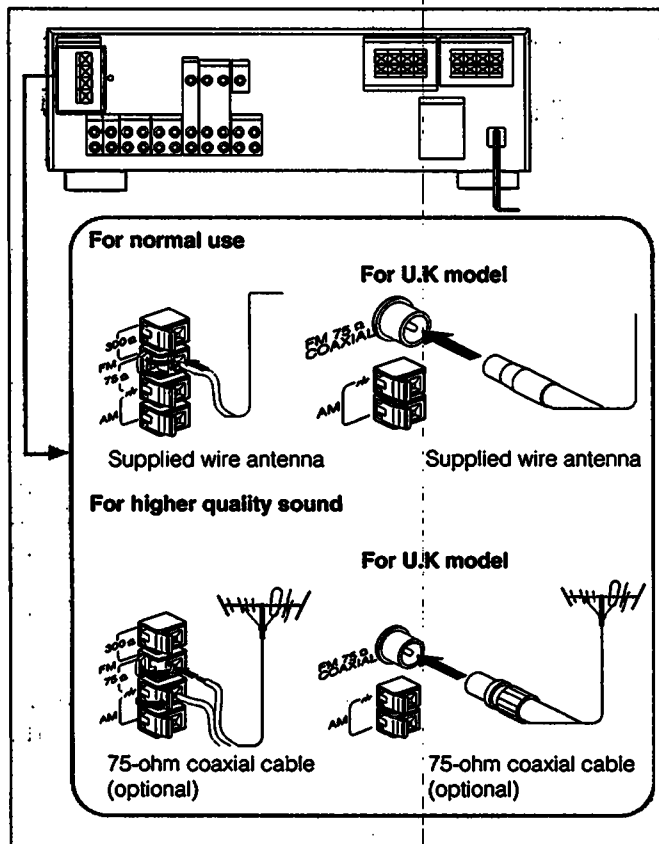

Connecting an AM Antenna

The AM broadcast is enough received with the supplied AM loop antenna. However, the connection of insulated wire is also available for areas with difficult AM reception.

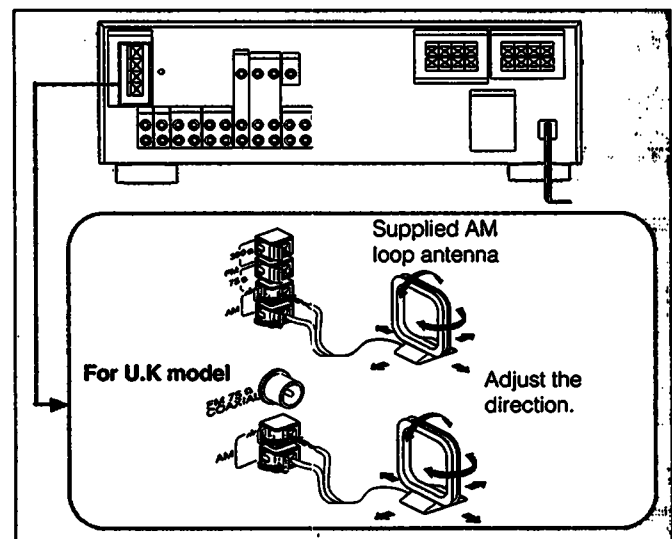

For areas with difficult AM reception

In areas with troubled reception, connect a 6 to 15-meter (20 to 50-foot) insulated wire to the AM antenna terminal. Extend this out of doors if possible, keeping the greater portion horizontal. (There is no need to disconnect the supplied antenna.)

Connecting the Antenna Ground

To prevent hum, connect the ground wire to ANTENNA ground terminal (⌚). When an outdoor antenna is installed, be sure to connect the ground wire for lightning protection.

Hooking Up the System

Connecting Speaker Systems

Front, rear and center speakers can be connected to this unit.

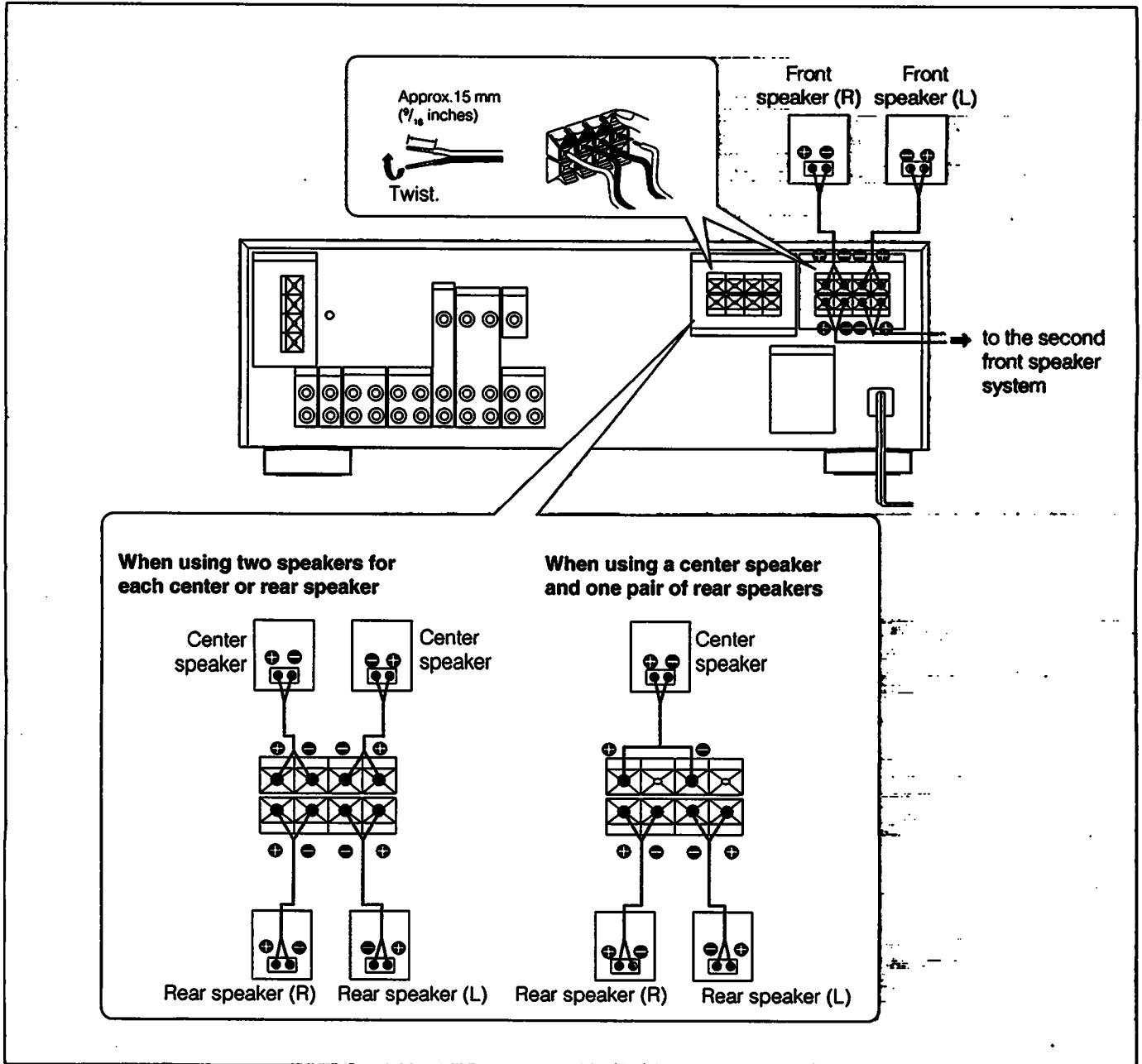

Speaker impedance and power capability

This receiver is designed to work best with speakers having nominal impedance from 8 to 16 ohms. Be sure to use a speaker system with adequate nominal impedance and power handling capabilities.

When using two center speakers, use the speakers having nominal impedance from 4 to 16 ohms.

Also, use all speakers to be connected with the equal efficiency.

Note

When connecting the speaker cord to the speaker terminal, make sure that the polarity (+ and -) of the speaker cord is correct. If the polarity is reversed at either speaker, the sound will be distorted and will lack bass.

Connecting to the AC Power Outlet

Connect the AC power cord to the wall outlet last of all. By connecting the power cord of the other audio equipment to SWITCHED AC OUTLET, this unit can supply the power source to the other audio equipment.

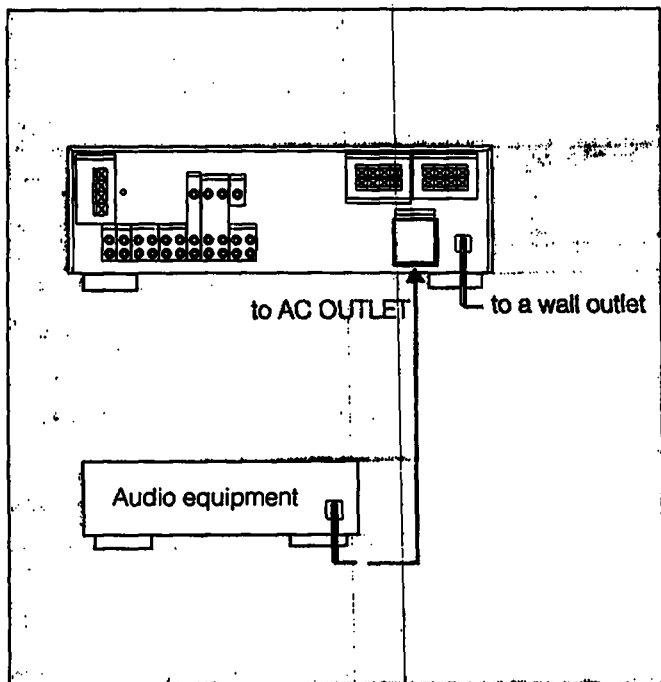

Caution

Be careful that the total power consumption of each equipment connected to the outlets on the receiver does not exceed 120 watts for USA and Canada models or 100 watts for UK model.

Do not connect electrical home appliances such as an electric iron, fan, TV, or other high-wattage equipment to these outlets.

Parts Identification

Front Panel

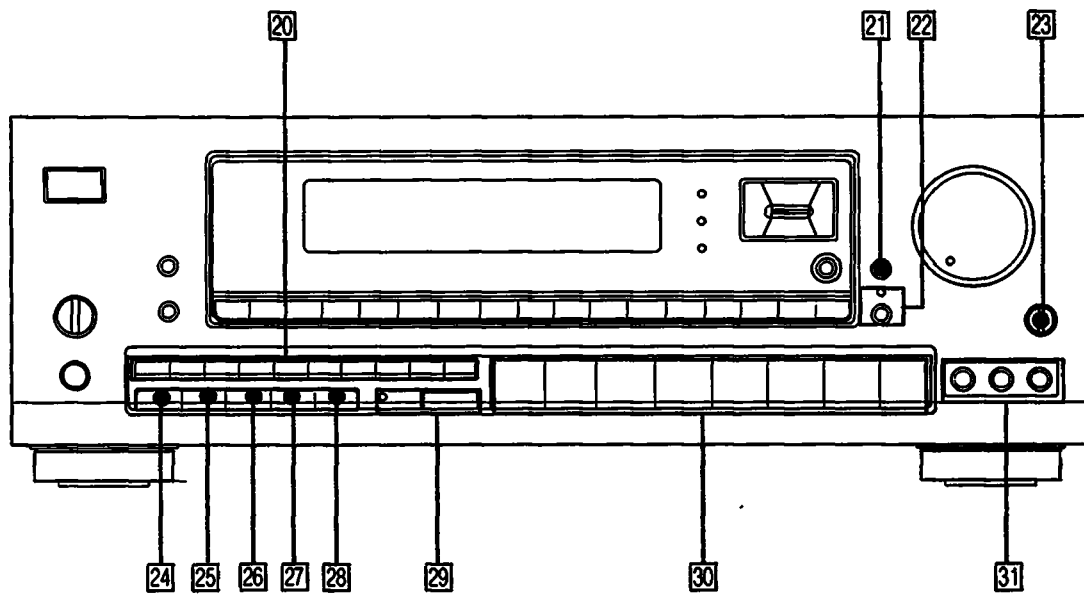
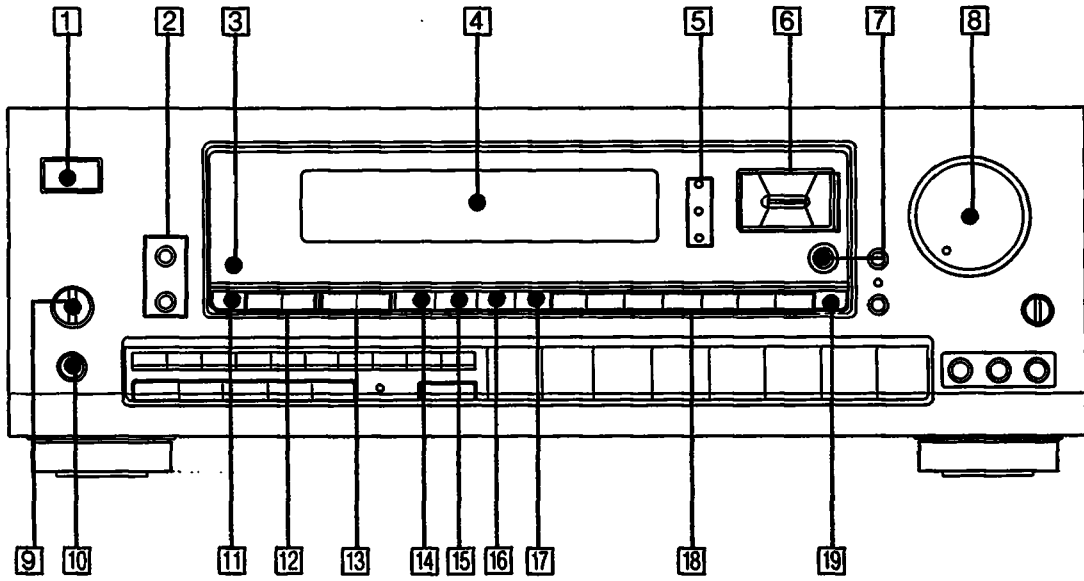

- 1 POWER switch**
(The STANDBY indicator lights up when the power cord is connected.: STR-D790 for UK model only)
- 2 EDIT VIDEO/AUDIO buttons** (See pages 24, 25, 26.)
(EDIT VIDEO button: STR-D990 only)
- 3 Remote sensor**
- 4 Display window**
- 5 CURSOR MODE indicators**
- 6 CURSOR MODE operation buttons**
(See pages 16, 21, 28, 29, 31.)
- 7 CURSOR MODE button** (See pages 16, 21, 28, 29, 31.)
- 8 MASTER VOLUME control** (See page 14.)
- 9 SPEAKERS selector** (See page 14.)
- 10 HEADPHONES jack**
- 11 FREQ/INDEX button** (See pages 18, 22.)
- 12 PRESET TUNING \rightarrow / \leftarrow buttons**
(See pages 20, 22.)
- 13 INDEX SELECT/TUNING \rightarrow / \leftarrow buttons**
(See pages 18, 22.)
- 14 TUNING LEVEL** (See page 18.)
- 15 LINK ON/OFF button** (See page 32.)
- 16 SOUND FIELD ON/OFF button** (See pages 28, 29.)
- 17 DOLBY PRO LOGIC MODE button**
(See pages 27, 28.)
- 18 SOUND FIELD buttons**
(See pages 28, 29, 30, 31, 32.)
- 19 TONE ON/DEFEAT button** (See page 31.)
- 20 Numeric buttons** (See pages 17, 19, 20, 21, 22.)
- 21 DBFB button** (See page 14.)
- 22 MUTING button and indicator** (See page 14.)
- 23 BALANCE control** (See page 14.)
- 24 SHIFT button** (See pages 19, 20.)
- 25 MEMORY button** (See page 21.)
- 26 DIRECT button** (See page 17.)
- 27 FM MODE button** (See page 17.)
- 28 FM/AM button** (See pages 17, 18.)
- 29 TAPE 2 MONITOR button and indicator** (See page 23.)
- 30 Function selectors**
(VIDEO 3 button: STR-D990 only)
- 31 VIDEO 3 INPUT jacks** (STR-D990 only)

Parts Identification

Remote Commander (except for U.K. model)

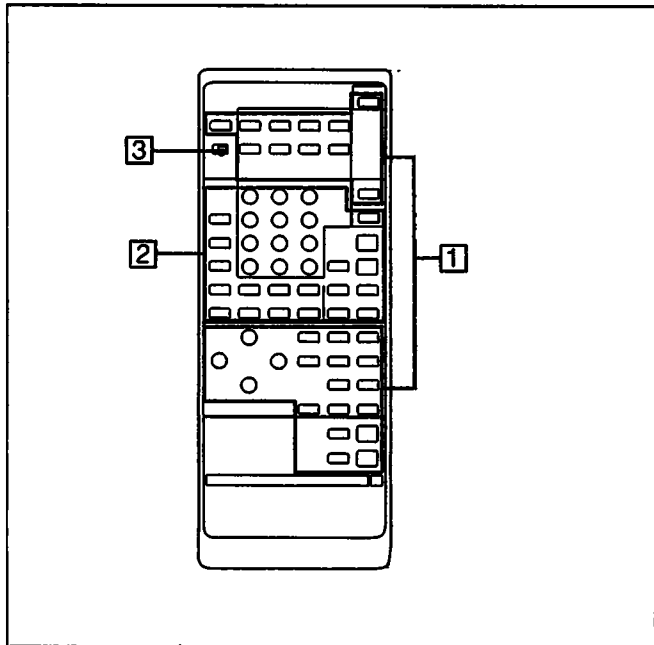

1 Receiver control section

FUNCTION:

DAT, CD, TUNER, PHONO, VIDEO 1, VIDEO 2, VIDEO 3, TAPE, The each function is selected and the each unit enters its operating mode automatically.

SYSTEM OFF: Turns off the power of the whole system.

POWER: Turns on the power of the receiver.

SOUND FIELD buttons

U/P: This button does not function.

MODE: Selects the sound field mode.

ON/OFF: Turns on/off the sound field system.

BAND: This button does not function.

EQ: Turns on/off the setting of TONE controls.

T. (test) TONE: Generates a pink noise signal that is sent in succession to each speaker.

CURSOR MODE: Select CURSOR MODE.

CURSOR operating buttons

REAR LEVEL +/- buttons: Control the volume of rear speakers (surround level).

CENTER LEVEL +/- buttons : Control the volume of center speaker (surround level).

DBFB button: Turns on/off the DBFB (Dynamic Bass Feedback).

MUTING button: Mutes the sound.

MASTER VOL +/- buttons: Control the receiver volume.

SLEEP: Set to the SLEEP timer mode. In this mode, the unit is automatically turned off after the designated time. (page 15)

2 Other equipment control section

Numeric buttons (1 to 0): Designate the number.

ENTER: Press after designating the TV/VCR channel.

SHIFT: Select the memory page (A, B or C).

TV/VIDEO selector: Selects the program to see : TV or VIDEO.

ANT TV/VTR button: Selects the output signal from the antenna terminal on the VCR, either a TV signal or VCR programs.

CH/PRESET +/- buttons: Select a preset channel.

INDEX: Set to the index tuning mode.

◀▶▶▶: fast winding/Manual search

●: Recording

▶▶▶▶: Play

■: Stop

||: Pause

◀◀◀◀: Locates a desired selection.

REV/FWD: Press ● and REV or FWD at the same time.

D (disc) SKIP: Disc skip (for a CD player equipped with a multi-disc changer)

SELECT: Changes the settings of the FUNCTION buttons.

3 SYSTEM/TV mode switch

In TV mode (When setting the SYSTEM/TV selector to TV.)

Only MUTING, MASTER VOL +/- and the operative buttons in TV section on the list described on the next page can be used.

Operating with the Remote Commander

Before operating the equipments with the remote commander, be sure to set the receiver to the desired mode by pressing one of the FUNCTION buttons.

The FUNCTION buttons are factory set in the following list.

FUNCTION to be pressed	Operating equipment
DAT	DAT
CD	CD player
TUNER	Tuner
PHONO	(The receiver enters the PHONO mode.)
VIDEO 1	Betamax VCRs
VIDEO 2	LD player
VIDEO 3	8 mm VCRs
TAPE	Tape deck A

- When VIDEO 1, 2 or 3 is pressed, the power of the selected video equipment and TV is turned on.

Operating the equipment

- 1 Press the desired FUNCTION.
- 2 Press ◀ (only for tape deck) or ▶ to start playback.

Changing the settings of the FUNCTION Buttons

With the SELECT button, you can replace the functions stored in the FUNCTION buttons.

To change the settings of the FUNCTION buttons

- 1 Press one of the FUNCTION buttons to be stored.
- 2 Press SELECT.
- 3 Press the 1 to 9 button to select the desired function within 30 seconds.
- 4 Press ENTER.

To operate other unit temporarily without changing the settings of FUNCTION

- 1 Press SELECT.
- 2 Press the 1 to 9 button to select the function.
- 3 Press the desired button.

After operating the unit, the receiver enters the previous mode.

Operative buttons: POWER, ◀▶▶▶, ◀▶▶▶▶, ■, ◀▶, ■, ●REC, D.SKIP, TV/VIDEO, ANT TV/VTR, CH/PRESET +/-, SHIFT, INDEX.

Example:

To record the program source in DECK A in the CD mode

- 1 Press SELECT.
- 2 Press 3 (DECK A).
- 3 While pressing ●, press REV or FWD.

After operating DECK A, the receiver enters the CD mode automatically.

List of operative buttons in SYSTEM mode (When setting the SYSTEM/TV selector to SYSTEM)

Operating equipment	TUNER	CD	DAT	DECK A, B	TV	LDP	VTR 1, 2, 3
1	•	•	•	—	•	•	•
2	•	•	•	—	•	•	•
3	•	•	•	—	•	•	•
4	•	•	•	—	•	•	•
5	•	•	•	—	•	•	•
6	•	•	•	—	•	•	•
7	•	•	•	—	•	•	•
8	•	•	•	—	•	•	•
9	•	•	•	—	•	•	•
0	•	—	—	—	•	•	•
ENTER	—	—	—	—	•	—	•
SHIFT	•	—	—	—	—	—	—
TV/VIDEO	—	—	—	—	•	★	★
ANT TV/VTR	—	—	—	—	—	—	•
CH PRESET +/-	•	—	—	—	•	—	•
INDEX	•	—	—	—	—	—	—
D.SKIP	—	•	—	—	—	—	—
▶▶	—	•	•	•	—	•	•
◀◀	—	•	•	•	—	•	•
▶▶◀	—	•	•	—	—	•	—
◀◀▶	—	•	•	—	—	•	—
REV or ◀+●	—	—	—	•	—	—	—
FWD or ▶+●	—	—	•	•	—	—	•
■	—	•	•	•	—	•	•
◀	—	—	—	•	—	—	—
▶	—	•	•	•	—	•	•
■	—	•	•	•	—	•	•

•: The button is operative.

—: The button is not operative.

★: The button can operate TV and VTR connected to TV.

Note

To operate the unit correctly, the function mode of the receiver should be same with that of the remote commander. So, be sure to press the desired FUNCTION button at first and then the operative button.

Adjusting Basic Audio Controls

You can enjoy superb sounds using the audio adjustment functions as shown below.

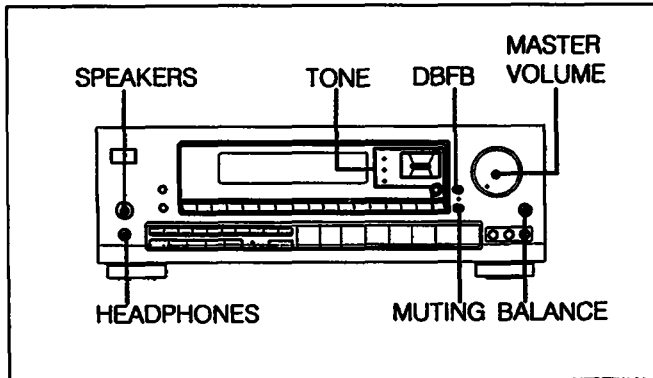

Adjusting Volume

To adjust volume
Turn MASTER VOLUME.

To reduce the sound to a low level temporarily (- 20 dB attenuation)
Press MUTING. The indicator lights up.
Press again to restore the same listening level as before.

Adjusting Left and Right Sound Balance

Adjust BALANCE to correct stereo imaging, when the speaker position is not symmetrical.

Adjusting Tone from the Front Speakers

Press TONE ON/DEFEAT to set to ON and then press CURSOR MODE so that TONE lights up. Press < or > to select BASS or TREBLE respectively and then press Δ or ▽ to adjust the level.

Reinforcing the Bass

Press DBFB (Dynamic Bass Feedback) so that DBFB ON appears on the display. Press again to turn off the effect so that DBFB OFF appears on the display.

Selecting the Speaker System

To drive speaker system A: Set SPEAKERS to A.
To drive speaker system B: Set SPEAKERS to B.
To drive both speaker systems A and B (series connection): Set SPEAKERS to A + B.
For headphone listening: Connect headphones to HEADPHONES and set SPEAKERS to OFF.

IMPORTANT

Speaker systems A and B are series connected. When only one speaker system is connected, no sound can be heard at the A + B position.

Selecting a Program Source

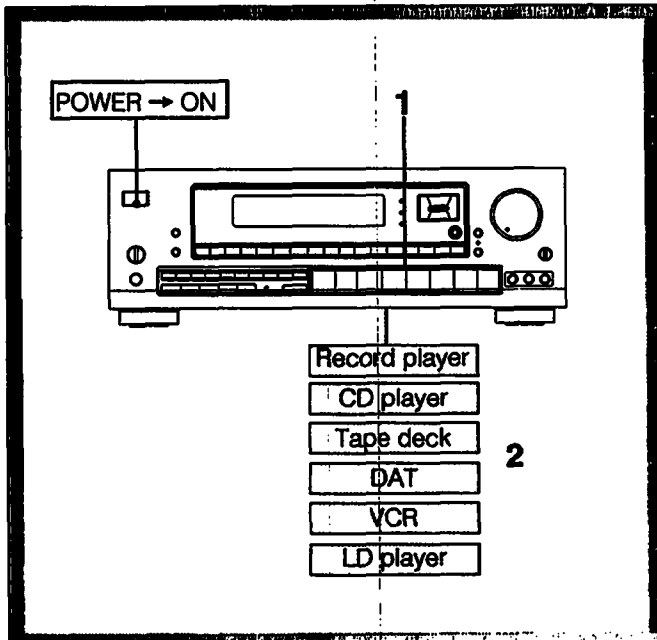

1 Select the program source.

What you select	Press
Phono record	PHONO
Radio Broadcast	TUNER
Compact disc	CD
DAT program	DAT
Taped program	TAPE 1, TAPE 2
Video program	VIDEO 1, VIDEO 2/LD, VIDEO 3

When a function selector is pressed, the indicator of the function you have selected appears on the display.

Select the function with the remote commander, the power switches of both this receiver and the selected equipment are turned on.

2 Start playback of the selected program.

To Turn Off the Power at the Desired Time (The Sleep Timer Function)

This function can be operated only with the remote commander.

This receiver has the sleep timer function. With this function, you can turn off the power automatically at the desired time by designating the turn-off time.

Press SLEEP on the remote commander when the power is on. Each time SLEEP is pressed, the designating time is displayed in the following order: 2 hours → 1 hour and 30 minutes → 1 hour → 30 minutes → SLEEP OFF.

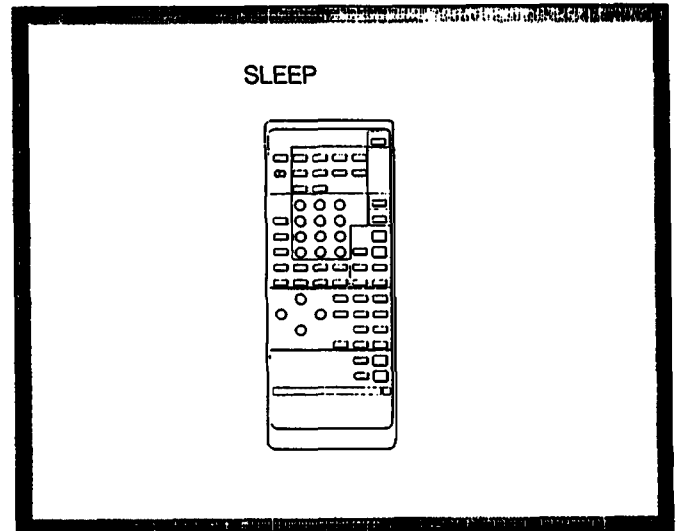

To change the turn-off time

1 Press SLEEP and the remaining time is displayed.

2 Press Δ or ∇ to change the sleep time. The sleep time is changed by 1 minute. It can be changed up to 5 hours and 00 minutes (and 00 seconds).

To check the remaining time of the sleep timer

Press SLEEP. The remaining time is displayed.

Selecting a Program Source

Labeling the Program Source

You can input program sources under index names you create (up to 11 characters); for example, PHONO, TUNER, CD etc.

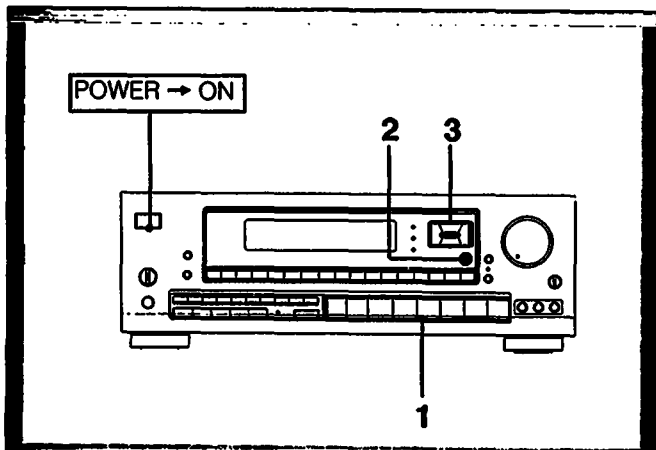

1 Select the program source.

2 Press CURSOR MODE to select the INDEX mode.

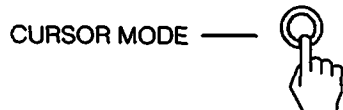

The INDEX indicator lights up.

3 Create an index name.

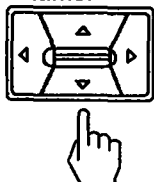

To select a letter (A to Z) or number (1 to 9), press Δ or ∇ .

To change the position, press \triangleleft or \triangleright .

4 Repeat steps 1 to 3 for all other program sources you want to assign an index name to.

If you input an already store source under any other index name

Only the last selected index name will be valid. Each program source can be stored under only one index name.

To switch the display mode between the original function name display and created index name display
Each time the **FREQ/INDEX** is pressed, the selected function name (which corresponds to the function selector) and the created index name are alternately displayed.

Receiving Broadcasts

Tuning in a Station Directly (Direct Tuning)

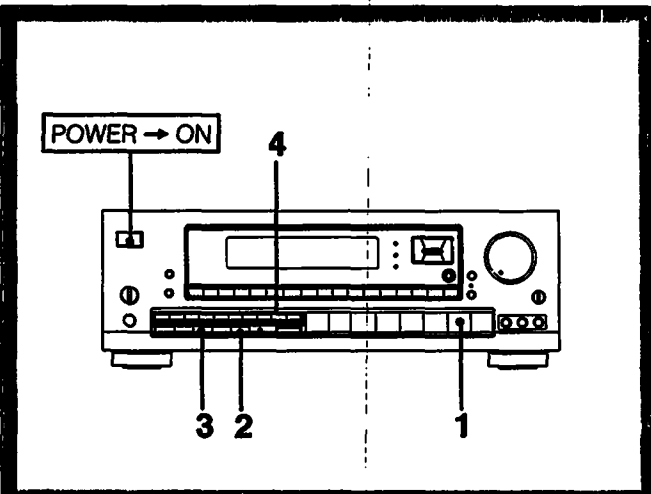

1 Press TUNER.

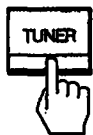

TUNER frequency appears on the display.

2 Select FM or AM.

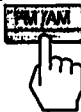

3 Press DIRECT.



4 Enter the frequency.

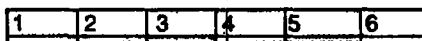

The entered frequency is displayed.

Example 1: FM 102.50 MHz

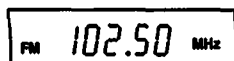
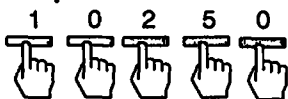

Example 2: AM 1350 kHz

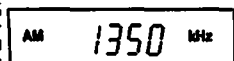
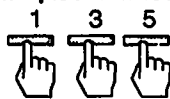

To correct the entered frequency

Repeat steps 3 to 4.

For entering AM frequencies

You need not enter the last "0". (except for U.K. model)
However, if you have changed the AM tuning interval to 9 kHz, enter all the digits.

If you enter a frequency not covered by the tuning interval

The entered value is automatically rounded up or down to the closest value covered by the tuning interval.

Tuning intervals for direct tuning are the followings:

FM: 50 kHz interval

AM: 10 kHz interval (changeable to the 9 kHz interval)

(See page 5)

9 kHz interval (only for STR-D790 U.K. model)

When the entered frequency does not exist in the receivable frequency range

The entered digits (up to 5 digits for FM or up to 3 digits for AM) blink in the frequency display area, and reception does not take place.

If this occurs, press DIRECT again, and enter the correct frequency. The frequency range of the receiver is 87.50 to 108.0 MHz for FM, and 530 to 1710 kHz or 531 to 1602 kHz (only for STR-D790 U.K. model) for AM.

When an FM stereo program is noisy

When the unit receives an FM stereo program, the STEREO indicator lights in the display window. If the stereo program is noisy, press FM MODE to change the mode over the MONO. This eliminates the stereo effect, but the noise will be greatly reduced.

To return to the stereo mode, press FM MODE again.

Receiving Broadcasts

Scanning Stations Automatically (Auto Tuning)

When you do not know the frequency of the station to be received, proceed as follows.

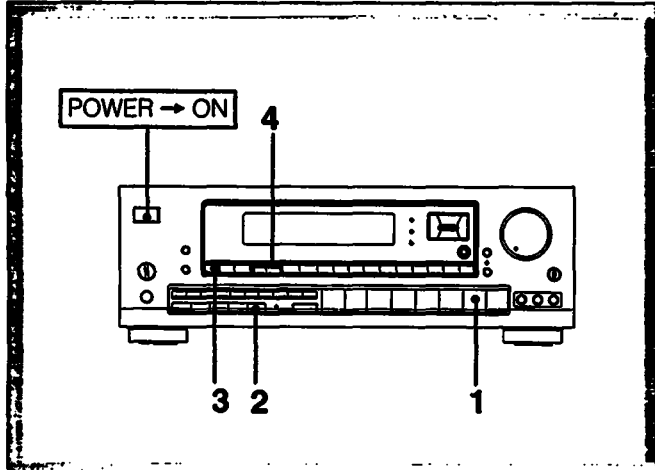

5 Repeat step 4 until the desired station is received.

If the automatic scan stops frequently (for FM reception only)

You can receive only the strong stations by pressing TUNING LEVEL. HIGH appears on the display.

To receive all receivable stations again
Press TUNING LEVEL so that HIGH goes off.

1 Press TUNER.

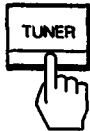

TUNER frequency appears on the display.

2 Select FM or AM.



3 Press FREQ/INDEX to set to the FREQ mode.



The frequency appears on the display.

4 Press INDEX SELECT/TUNING - or +.

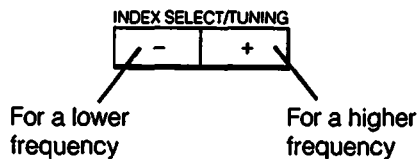

When a station is received, automatic tuning stops.

Presetting Stations (Station Preset)

A total of 30 FM/AM stations can be memorized in any desired sequence.

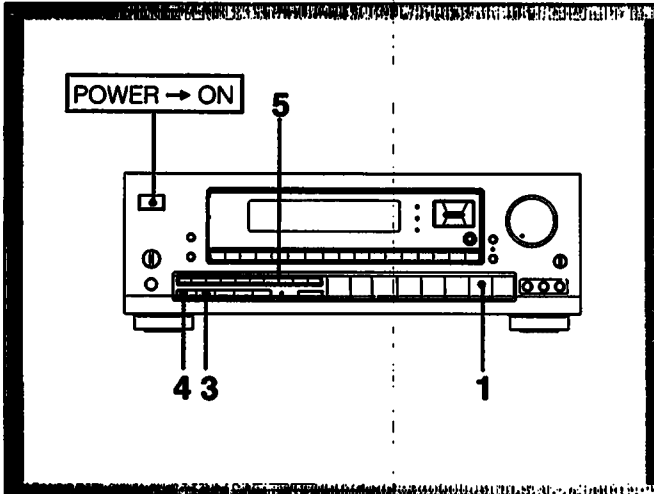

1 Press TUNER.



TUNER frequency appears on the display.

2 Tune in the desired station. (See "Auto Tuning" or "Direct Tuning".)

3 Press MEMORY.



MEMORY appears on the display.

4 While MEMORY appears, select the memory page (A, B or C).



Each time SHIFT is pressed, A, B or C is indicated cyclically.

5 While MEMORY appears, press the desired number.



Repeat above steps for presetting other desired stations.

Replacing a preset station

Preset another station on the number of the station to be replaced. The previously preset station will be erased.

Receiving Broadcasts

Tuning in a Preset Station (Preset Tuning)

There are two ways to perform the preset tuning. In method A, the direct tuning, select by designating the desired preset station number directly with the numeric button. In method B, the scan tuning, select the preset station with the PRESET TUNING $-/+$ button.

Method A: Direct tuning

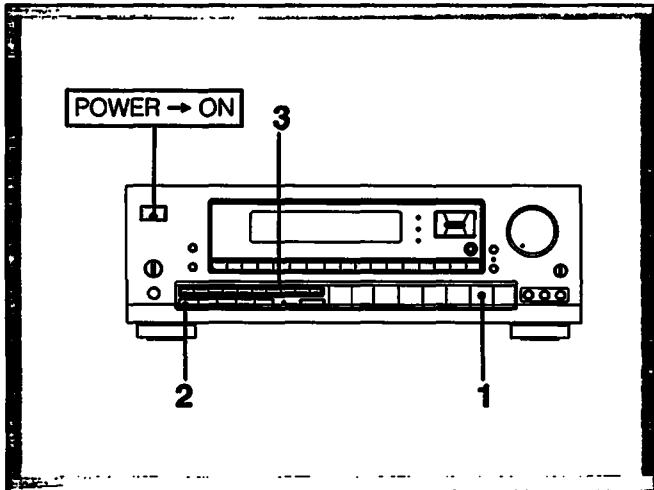

1 Press TUNER.

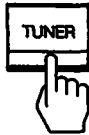

TUNER frequency appears on the display.

2 Select the memory page (A, B, or C).



Each time SHIFT is pressed, A,B or C is indicated cyclically.

3 Designate the desired preset station number with the numeric button.

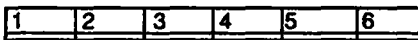

Method B: Scan tuning

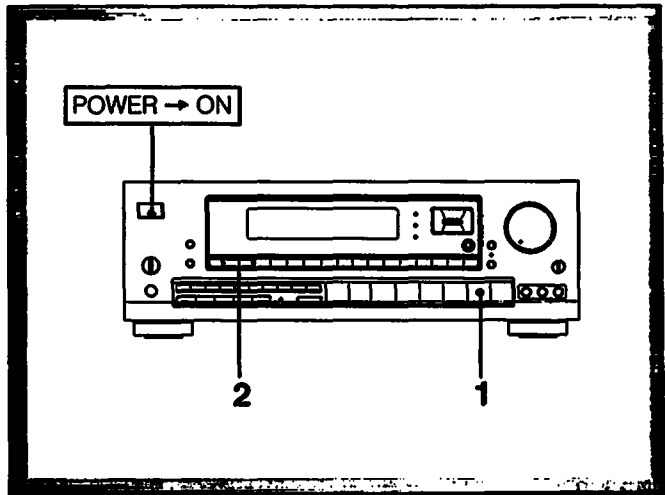

1 Press TUNER.

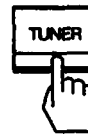

TUNER frequency appears on the display.

2 Select the desired preset station with PRESET TUNING $-$ or $+$.

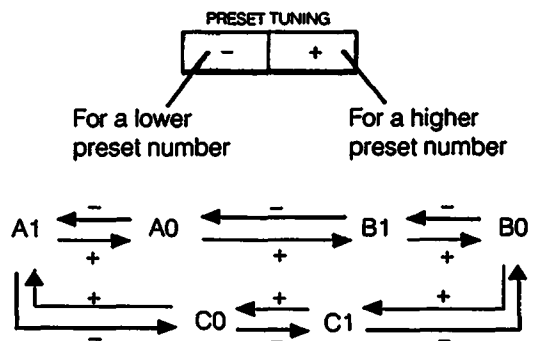

IMPORTANT

The memorized station is maintained for approximately one month even if the power cord is disconnected from the AC power outlet. If they are erased, store the stations again.

Labeling the Preset Stations (Station Index)

You can divide preset stations under index names you create (up to 5 characters). If you want to categorize the preset stations by kinds of music, for example, create indexes such as ROCK, JAZZ, etc.

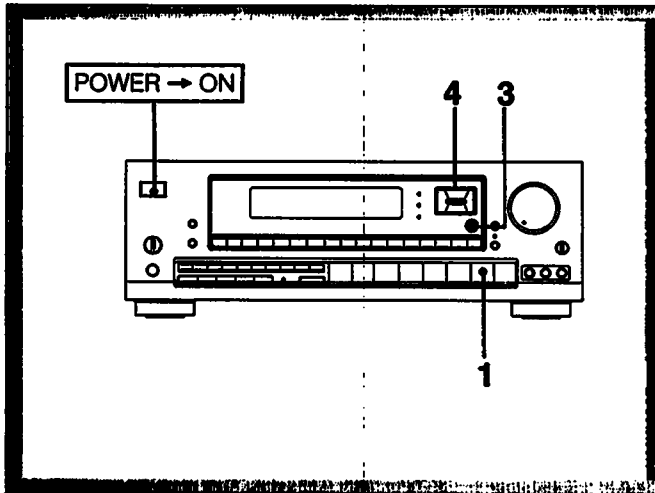

1 Press TUNER.



TUNER frequency appears on the display.

2 Tune in the desired station with Preset Tuning.

3 Press CURSOR MODE to select the INDEX mode.

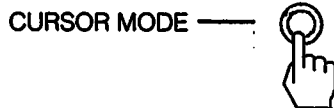

The INDEX indicator lights up.

4 Create an index name.

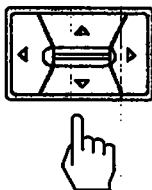

To select a letter (A to Z) or number (1 to 4), press Δ or ∇ .
To change the position, press \triangleleft or \triangleright .

5 Repeat steps 2 through 4 for all other stations you want to assign an index name.

If you store an already categorized station under any other index name

Only the last selected category will be valid. Each station can be stored under only one index name.

To display the frequency and index name of preset stations

Each time DISPLAY FREQ/INDEX is pressed, frequency and index name of the preset station are alternately displayed.

Receiving Broadcasts

Selecting a Station among the Preset Stations in the Index (Index Tuning)

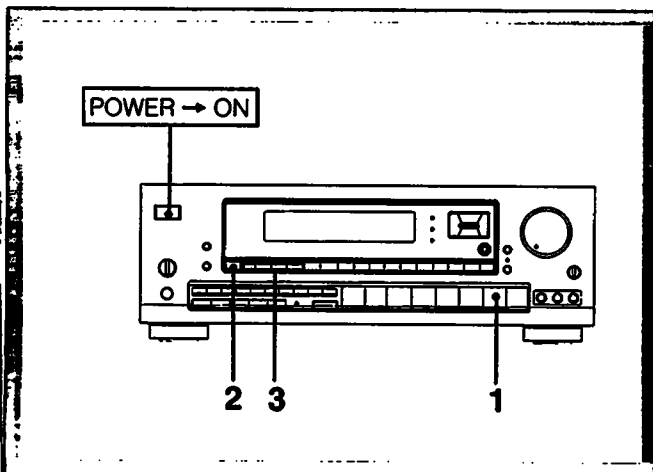

1 Press TUNER.

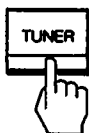

TUNER frequency appears on the display.

2 Press FREQ/INDEX to set to the INDEX mode.



When no index name is memorized, "no-index" appears on the display.

3 Select the desired station.

- To select a station in the same index:

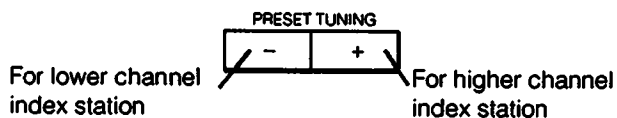

- To select a index station other than the displayed index station:

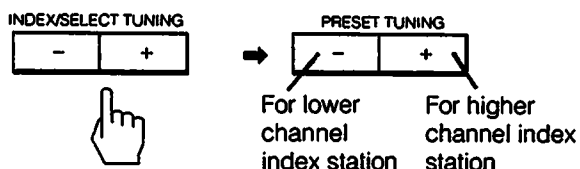

Receiving FM Simulcast TV Programs

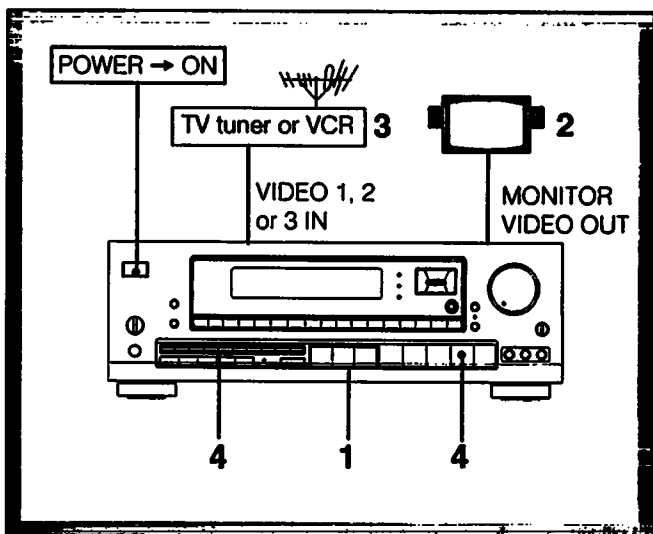

- Select VIDEO 1, VIDEO 2/LD or VIDEO 3 (STR-D990 only). VIDEO 1, VIDEO 2/LD or VIDEO 3 appears on the display. According to video inputs connected to an equipment to which the VHF antenna is connected.

- Turn on the monitor TV.

- Select the desired program on the TV tuner or the VCR.

- Select TUNER and tune in the FM simulcast TV program on the receiver.

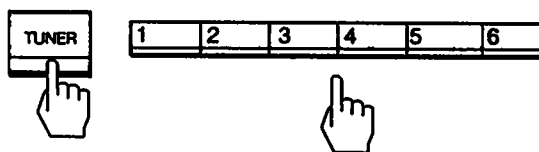

Recording an Audio Source

Recording onto an Audio Tape Deck or DAT Deck

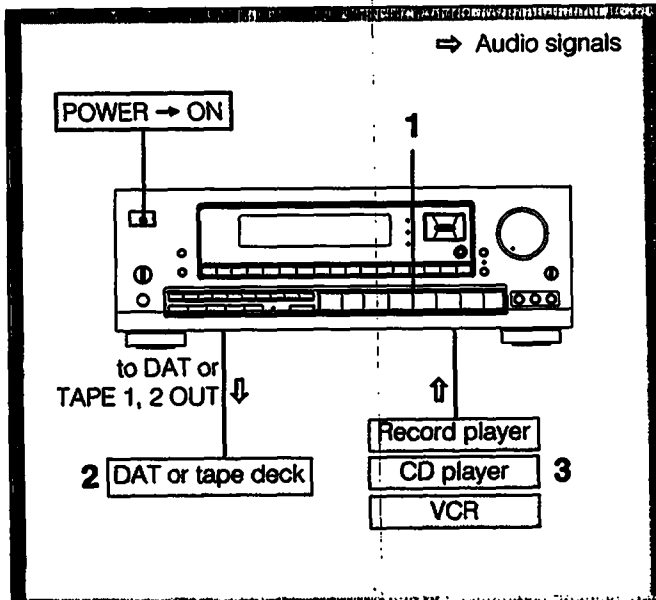

- 1** Select the desired program source with the function selector.
For an FM/AM broadcast, tune in the desired station.
- 2** Set the tape (DAT) deck in the recording mode.
- 3** Start playback of the selected program source.

Note on recording

For TAPE 1, 2 and DAT REC OUT jacks, the settings of SOUND FIELD and DBFB do not have any effect on recording.

Monitoring the recorded sound

If you have connected a 3-head tape deck to the TAPE 2 jacks, you can monitor the recording results. While recording or dubbing, press TAPE.2 MONITOR so that the TAPE 2 MONITOR indicator lights up. To listen to the source sound again, press the button again so that the indicator goes off.

Tape Dubbing

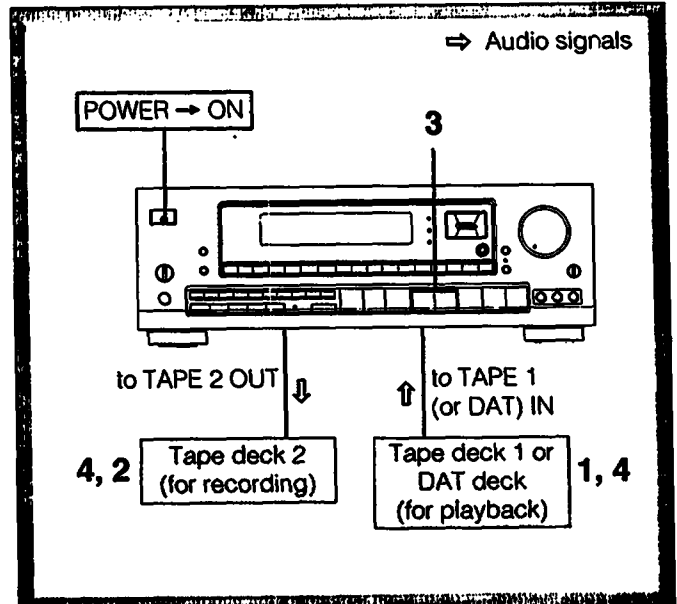

- 1** Insert the recorded tape into tape deck 1 (or the DAT deck).
- 2** Insert a blank tape into tape deck 2 and adjust the recording level.
- 3** Press TAPE 1 or DAT to select the deck for playback.
- 4** Start the playback of the tape (or the DAT) in tape deck 1 (or the DAT deck), and set tape deck 2 in the recording mode.
Dubbing will start.

Note on tape dubbing

Tape dubbing is possible only in the following directions:

From (Playback deck)	To (Recording deck)
Tape deck connected to TAPE 1 IN	Tape deck connected to TAPE 2 OUT
	DAT deck connected to DAT OUT
DAT deck connected to DAT IN	Tape deck connected to TAPE 1 or 2 OUT

Press the function selector according to the playback deck.

Editing a Video Source

Video Tape Dubbing

If the AUDIO indicator is lit in the display window, press the EDIT AUDIO button to make the indicator go out.

With the STR-D990

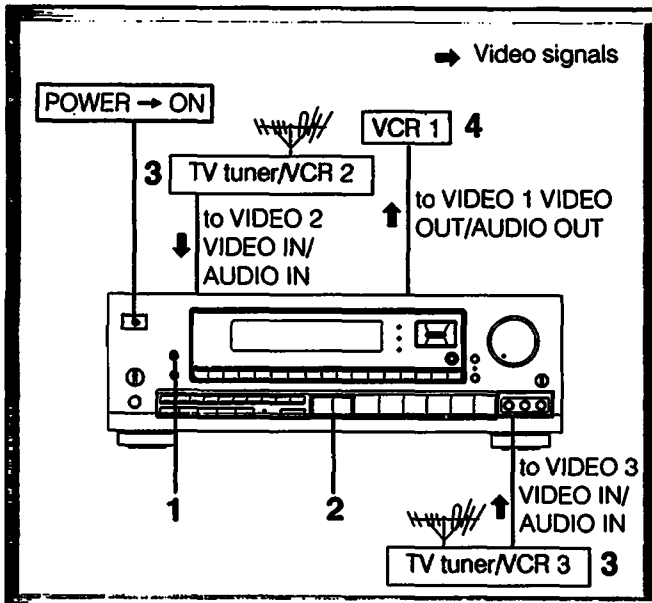

- 1** Select the playback VCR with EDIT VIDEO. To select VCR 2, press EDIT VIDEO so that "2> 1" appears on the display. To select VCR 3, press EDIT VIDEO so that "3> 1" appears on the display.
- 2** Press VIDEO 2/LD or VIDEO 3 to select the video signal to monitor on the monitor TV according to the VCR to be played. VIDEO 2/LD : for the VCR 2
VIDEO 3: for the VCR 3
- 3** Set the playback VCR to the playback mode.
- 4** Set the VCR 1 to the recording mode. Dubbing will start.

— Video editing —

To switch the playback VCR during dubbing

Press EDIT VIDEO. Each time you press the button, the playback VCR switches from the VCR 2 to the VCR 3 (or the VCR 3 to the VCR 2).

To view the other video source(s) on the monitor TV during dubbing

Press the appropriate function selector, VIDEO 1, VIDEO 2/LD, or VIDEO 3.

To listen to an audio program during video tape dubbing

- 1 Press the appropriate function selector.
- 2 Start the selected audio program source.

With the STR-D790

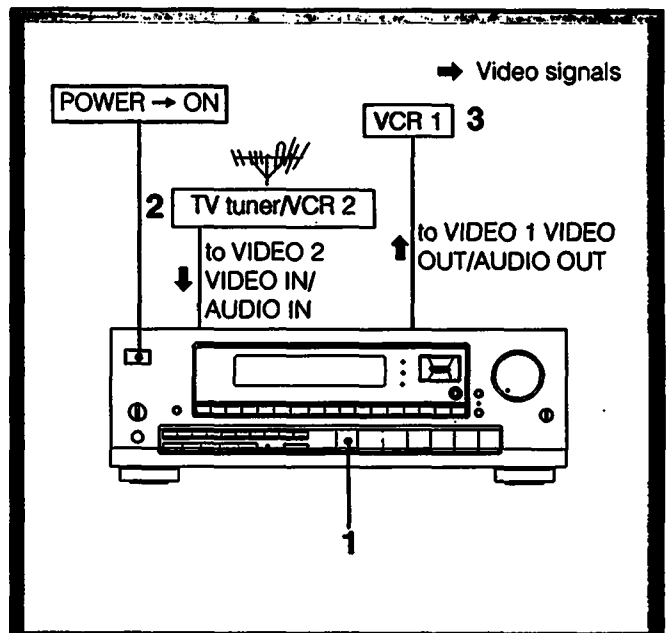

- 1** Press VIDEO 2/LD.
- 2** Set VCR 2 to the playback mode.
- 3** Set the VCR 1 to the recording mode. Dubbing will start.

To listen to an audio program during video tape dubbing

- 1 Press the appropriate function selector.
- 2 Start the selected audio program source.

To record a TV program

You can record a TV program on VIDEO 1.

Adding New Sound on a Video Tape during Video Editing

During video tape editing, you can add the desired sound on the recording VCR from various audio program sources.

With the STR-D990

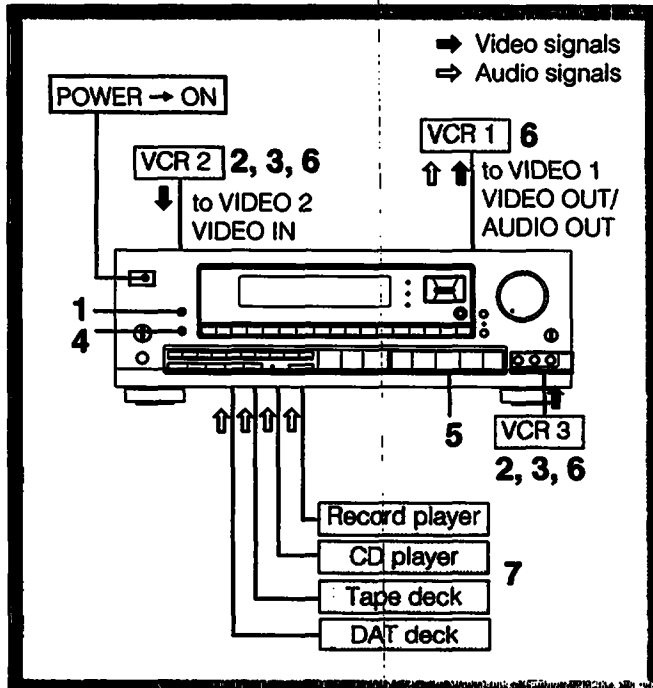

- 1 Select the playback VCR with EDIT VIDEO.**
To select VCR 2, press EDIT VIDEO so that "2▷" appears on the display.
To select VCR 3, press EDIT VIDEO so that "3▷" appears on the display.

- 2 Set the playback VCR to the playback mode.**

- 3 At the point where audio dubbing starts, press the pause button on the playback VCR.**

- 4 Press EDIT AUDIO.**



AUDIO appears on the display.

- 5 Select the audio program source with the function selectors.**

- 6 Release the pause mode of the playback VCR and set the VCR 1 to the recording mode.**

- 7 Start playback of the selected audio program source.**
Video dubbing starts and the audio program source is also recorded on the VCR 1 simultaneously.

Editing a Video Source

Adding New Sound on a Video Tape during Video Editing

With the STR-D790

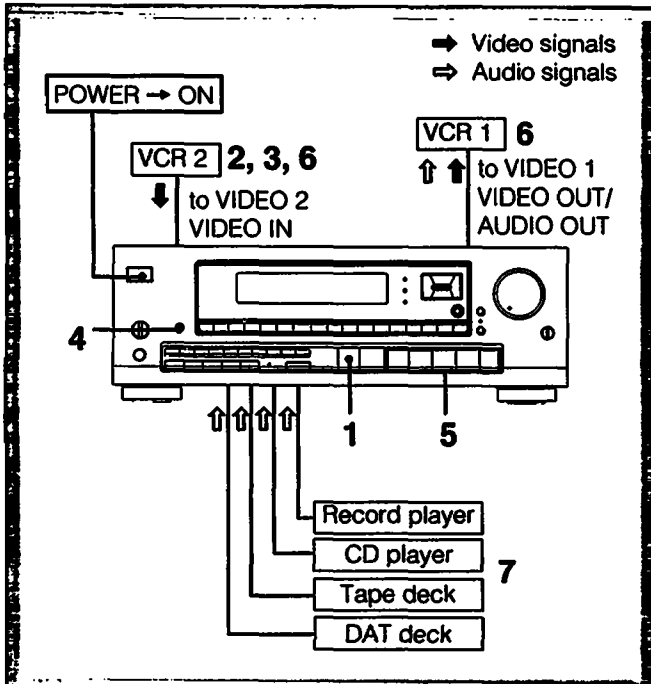

1 Press VIDEO 2/LD.

2 Insert a recorded video tape into VCR 2 and set the VCR to the playback mode.

3 At the point where audio dubbing starts, press the pause button on VCR 2.

4 Press EDIT AUDIO.



AUDIO appears on the display.

5 Select the audio program source with the function selectors.

6 Release the pause mode of VCR 2 and set VCR 1 to the recording mode.

7 Start playback of the selected audio program source. Audio dubbing will start.

Getting Ready for Dolby Surround Sound

This section describes about selecting the speaker configuration and then adjusting the speaker volume and the delay time of the rear speakers so that you can enjoy the Dolby surround sound.

Placement of Speakers and Selecting the PRO LOGIC MODE

The Dolby Pro Logic Surround Decoder has the same functions for playback, such as movie theaters and gives a theater-like experience in your listening room, naturally reproducing the audio sound field.

The STR-D990/D790 incorporates a decoder which reproduces the specially encoded surround sound of Dolby surround video programs.

In the Dolby surround mode, select the speaker operation mode according to your speaker configuration by pressing the DOLBY PRO LOGIC MODE button. Each time the DOLBY PRO LOGIC MODE button is pressed, the DOLBY PRO LOGIC MODE is changed in the following order: NORMAL → WIDE → 3 CH. LOGIC → PHANTOM

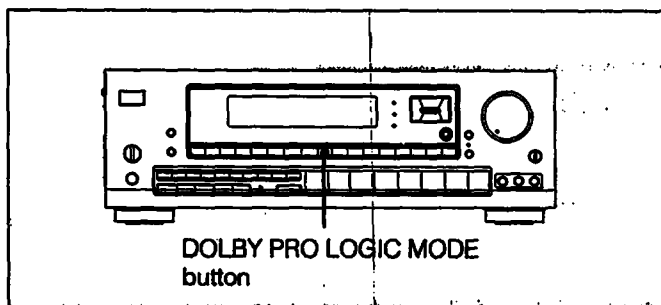

NORMAL mode

Select this mode if you use a small center speaker. The bass sound of the center channel is output from the front speakers, as a small speaker cannot produce enough bass.

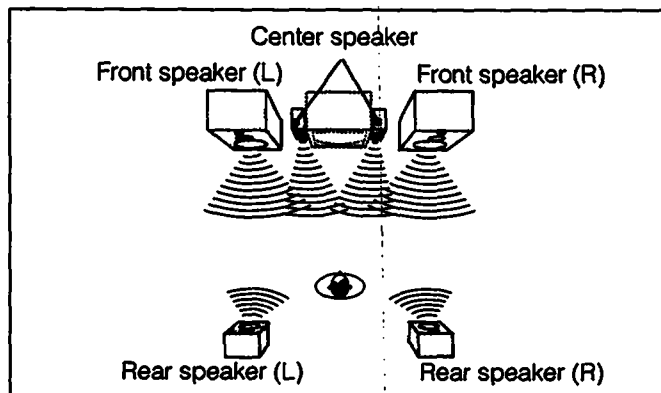

PHANTOM mode

Select this mode when you play back a Dolby surround program source without using a center speaker. The sound of the center channel is output from the front (L and R) speakers.

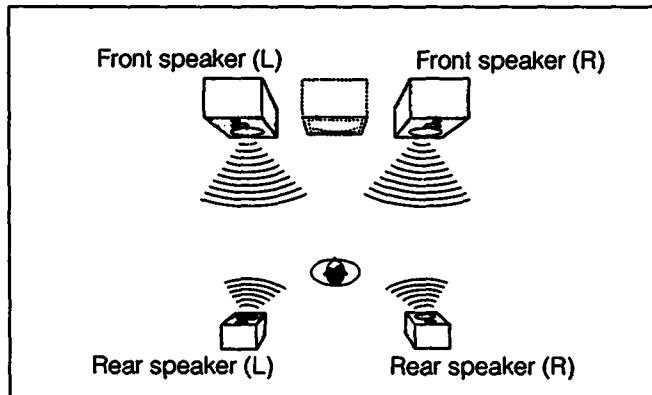

WIDE mode

Select this mode if you use a medium to big center speaker.

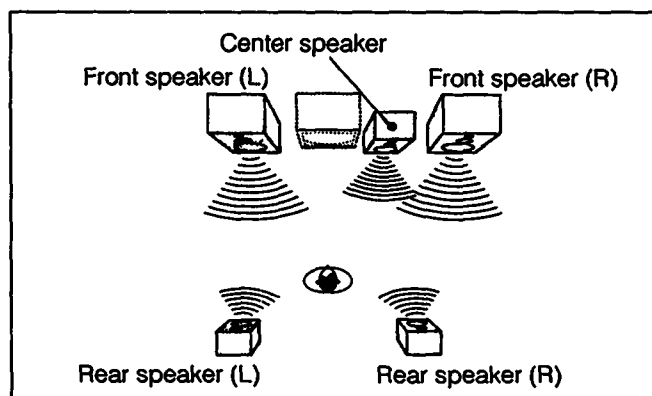

3CH. (Channel) LOGIC mode

Select this mode when you play back a Dolby surround program source only with the front and center speakers. The sound of the rear channel is output from the front (L and R) speakers.

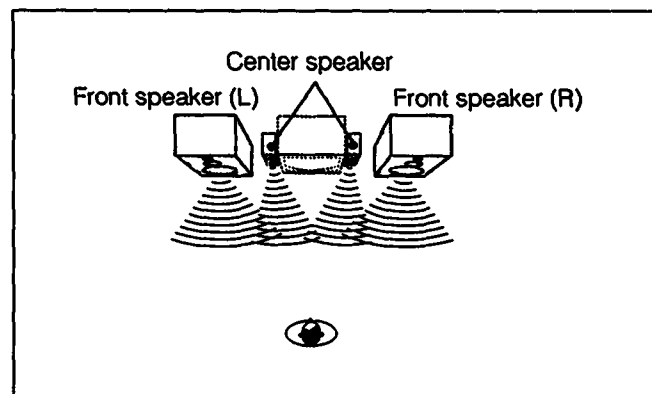

Even for video software which does not carry the mark

Some commercially available software may have Dolby surround processed sound tracks even though it is not so indicated on the package.

Getting Ready for Dolby Surround Sound

Adjusting the Speaker Volume

To enjoy the surround sound to the maximum on playing any program sources, adjust the front, rear, and center (if connected) speakers to the same volume level. The adjustment must be done with a test tone in the DOLBY SURROUND mode, but the level once adjusted can be used for all surround modes.

You can adjust the volume level from your listening position by using the remote commander.

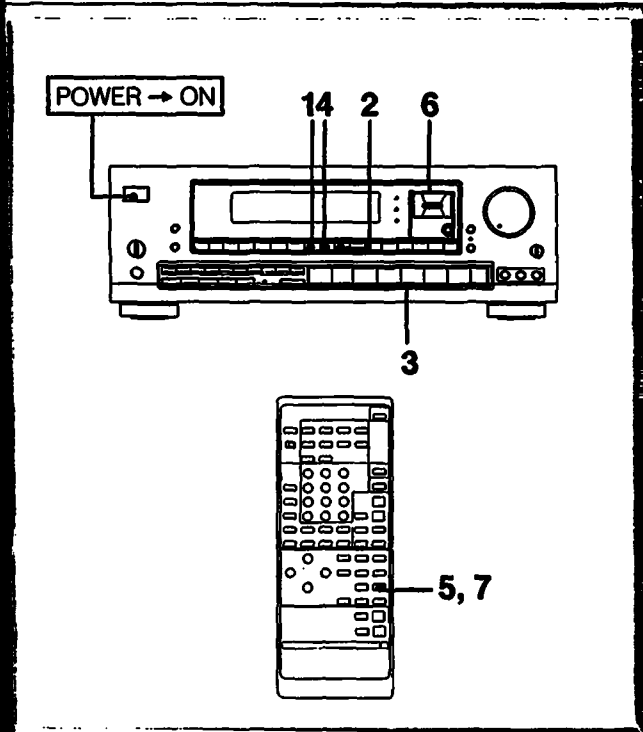

- 1 Press SOUND FIELD ON/OFF to ON.**
The last selected sound field is displayed in box.
- 2 Press DOLBY SUR.**
DOLBY SUR appears on the display.
- 3 Select a program source with the function selector and start playback.**
- 4 Select the Dolby pro logic mode with the DOLBY PRO LOGIC MODE button according to your speaker system.**
- 5 Press T. TONE on the remote commander to set to on.**

- 6 Press CURSOR MODE.**
The SURR (surround) indicator lights up.

To adjust the level of rear speakers
Press Δ or ∇ to select the rear level mode and then adjust the level with \triangleleft or \triangleright or REAR LEVEL +/- on the remote commander.

To adjust the level of center speakers
Press Δ or ∇ to select the center level mode and then adjust the level with \triangleleft or \triangleright or CENTER LEVEL +/- on the remote commander so that sound from each speaker is heard in the same volume level at the listening position. (When adjusting the VOLUME control on the receiver, all speakers are adjusted simultaneously.)

- 7 Press T. TONE on the remote commander to set to off.**

Sequence of the test tone

In a system with a center speaker:

The test tone will be output automatically from the front L, center, front R, and the rear speakers in succession.

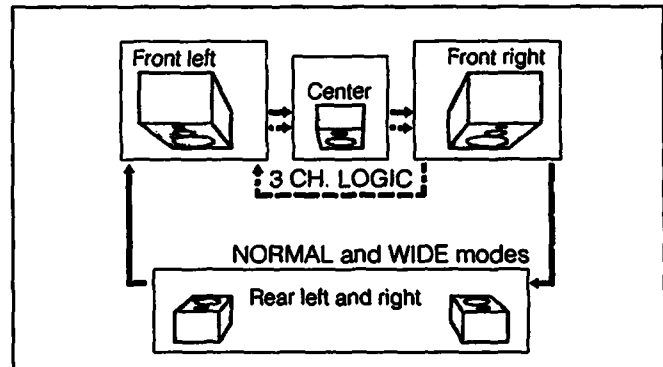

In a system without a center speaker:

The test tone will be output automatically from the front left and right speakers and the rear speakers alternately.

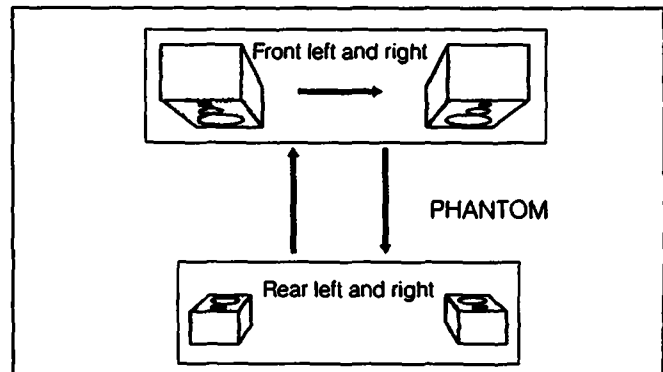

The receiver is preset in the factory to get an optimum surround level as long as each speaker has an equal efficiency.

Adjusting the Surround Sound

Adjusting the Delay Time of the Rear Speakers

— for Dolby surround mode

The delay time is a time between the surround sound from the front and that from rear speakers. The delay time is adjustable from 15 ms to 30 ms. (For other surround mode, the adjustable delay time is from 5 to 30 ms.)

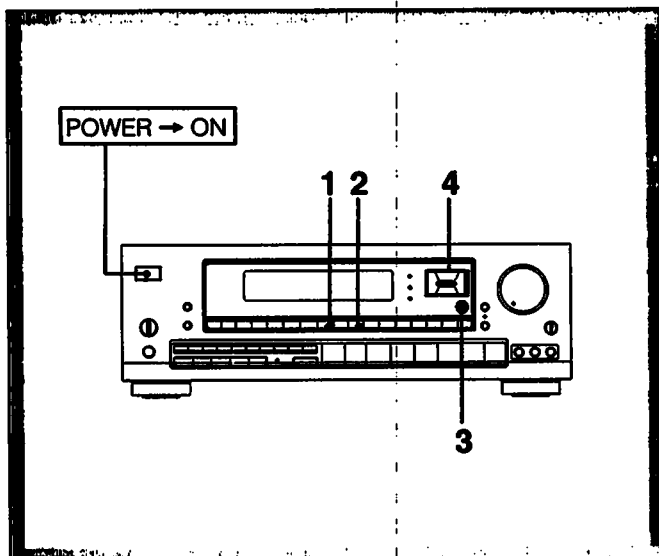

1 Press SOUND FIELD ON/OFF to ON.
The last selected sound field is displayed in box.

2 Press DOLBY SUR.
DOLBY SUR appears on the display.

3 Press CURSOR MODE.
The SURR (surround) indicator lights up.

4 Press Δ or ∇ to select the delay time mode and adjust the delay time with \triangleleft or \triangleright .

To turn off the surround effect

Press SOUND FIELD to OFF.

The normal sound without surround effect will resume.

Both level and delay time of the surround is memorized each time after adjusting with the cursor operation buttons. They will be restored when the surround mode is resumed.

Note

The delay time for the rear speakers can be adjusted even in the 3 CH. LOGIC mode.

Sound Field Settings

Available Type of Effects

7 recommended sound field programs (combination of the settings of the surround and tone control.) have been preset in the factory. Since these programs are appropriate for the most type of music and listening situations, you can enjoy the sound effect by selecting the desired sound field program according to the program source. And you can also manipulate various parameters to finely tune the factory-preset settings to your room, or create original sound effects as you like.

Sound field		DOLBY SUR	THEATER	LIVE	HALL	DISCO	SIMULATED	ACOUSTIC
Parameter								
Tone		•	•	•	•	•	•	•
Surround sound	Delay time	•	•	•	•	•	•	/
	Rear level	•	•	•	•	•	•	/
	Center level	•	•	/	/	/	/	/

DOLBY SUR: Decodes programs processed with the Dolby surround.

THEATER: Adds the reflection of a theater to decoded signals of the Dolby prologic decoder.

LIVE: Reproduces the acoustics of a large concert hall. It is effective for playing a program source with hard sound.

HALL: Reproduces the acoustics of a rectangular concert hall with soft sound. It is effective for playing a program source with hard sound.

DISCO: Boosts high and low frequencies and the dynamic sounds are reproduced.

SIMULATED: Gives a simulated stereo effect to monaural sound.

ACOUSTIC: The surround effect is defeated and only the tone control is available.

Adjusting the Tone Controls

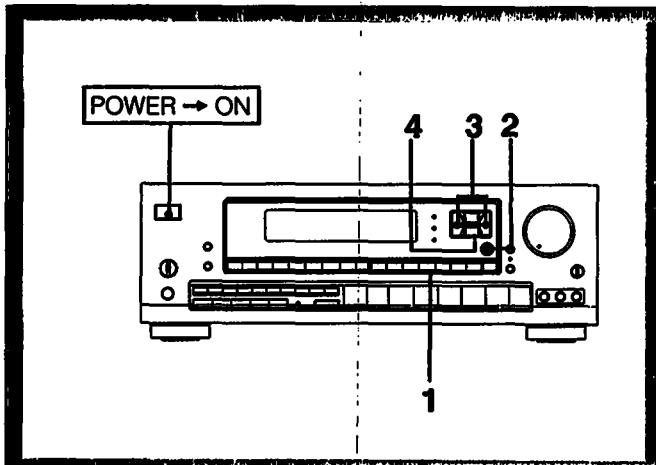

- 1** Press the desired SOUND FIELD program.
- 2** Press CURSOR MODE so that TONE lights up.
- 3** Press < or > to select BASS or TREBLE.
- 4** Press Δ or ∇ to adjust the level.

To defeat the TONE effect

Press TONE ON/DEFEAT to DEFEAT.
In the TONE DEFEAT mode, tone control cannot be adjusted.

Adjusting the Sound Field Programs

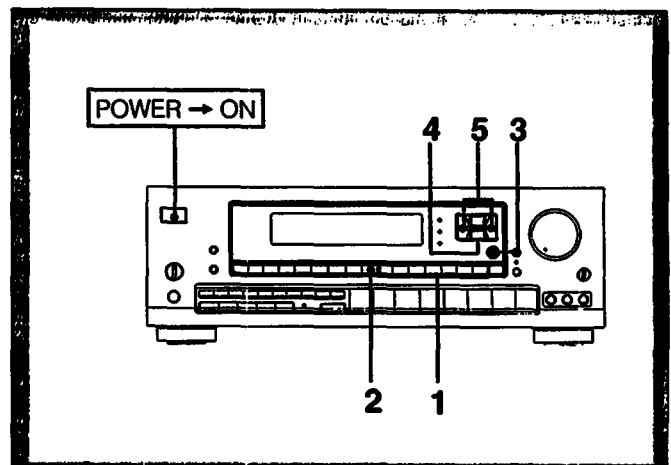

- 1** Press the desired SOUND FIELD program.
- 2** When DOLBY SUR or THEATER is selected on step 1, press DOLBY PRO LOGIC MODE to select the PRO LOGIC MODE.
- 3** Press CURSOR MODE so that SURR lights up.
- 4** Press Δ or ∇ to select the mode you want to adjust.
- 5** Press < or > to adjust the level or delay time.
After setting the surround program, the setting is stored automatically.

When you store a new SOUND FIELD effect

The previous SOUND FIELD effect is erased and the new one will be replaced.

Even if AC power cord is disconnected

The stored data is maintained for approximately 1 month.

When selecting ACOUSTIC

ACOUSTIC does not have the surround effect and only the effect of TONE controls can be available. So when selecting ACOUSTIC, only the setting of the TONE controls can be adjusted.

Sound Field Settings

Calling up the Sound Field Setting

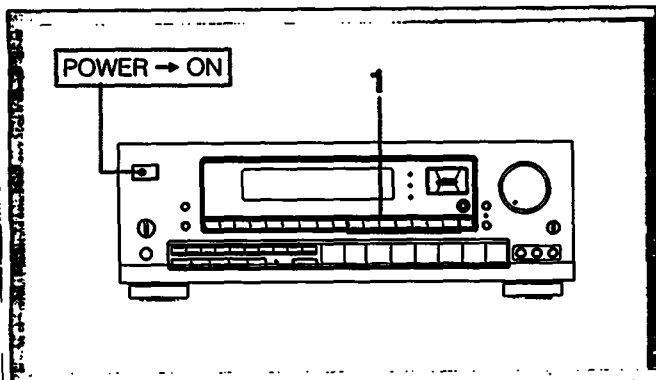

- 1** Press the desired **SOUND FIELD** program.

Restoring to the setting stored at the factory

Press **POWER** while pressing **TONE ON/DEFEAT**. All of the 7 settings are then restored.

Linking the Sound Field Memory to Preset Stations or Program Source

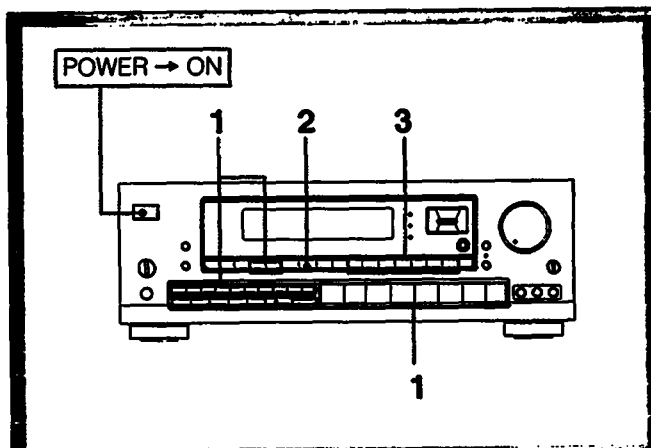

- 1** Tune in a station or select the program source to be linked with sound field data.

- 2** Press **LINK ON/OFF** to **ON**.

- 3** Press the desired **SOUND FIELD** program.

Notes

- When other sound field is selected in the **LINK ON** mode, the previous sound field setting linked with the preset station or program source is replaced with the newly selected one. Therefore, if you want to select other sound field without changing the sound field setting in memory, press **LINK ON/ OFF** to **OFF** and then select other sound field.
- When the sound field setting is adjusted, the sound field setting linked with the preset station or program source is also changed.

Troubleshooting Guide

Before proceeding through the check list below, examine the connections and the procedures outlined in the manual. Should any problem persist after you have checked the following items, consult your nearest Sony dealer.

Problem	Cause	Solution
No FM station can be located by Auto-Tuning operation.	The signal strength of the stations is too weak.	Press TUNING LEVEL to set the receiving signal level low. Check the antenna connection.
The STEREO indicator flickers or does not appear when receiving stereo programs.	A very weak FM station or a noisy FM program is received.	Adjust the antenna or connect an external FM antenna. Press FM MODE to set to MONO mode.
No station can be tuned in by Auto-Tuning operation.	The AM tuning interval is set incorrectly. The signal strength of the station is too weak for Auto-Tuning.	Change the tuning interval according to the AM frequency allocation system of your country. (See page 5) Adjust the antenna. Directly tune in the stations. (See page 17)
No stations can be tuned in by pressing PRESET TUNING +/-.	No stations have been preset.	Preset the stations. (See page 19)
No sound is heard even if you adjust VOLUME.	The speaker or program source equipment is not connected correctly. The SPEAKERS selector is not set correctly. TAPE 2 has been pressed for a program source other than tape deck 2. (The indicator is lit.) A wrong function selector has been pressed. The function switch on the VCR is not set correctly.	Connect the equipment correctly. Set the selector correctly. Press the button to disengage. Press the correct function selector. Check and set it correctly.
No sound or sound at very low level is heard from rear speakers.	SOUND FIELD function is turned off. Monaural program source is played back in Dolby surround mode.	Press SOUND FIELD ON/OFF to turn on the function. Select the other modes.
Sound is heard only at a very low volume.	MUTING has been pressed. (The MUTING indicator is lit.)	Press the button to disengage.
One channel does not transmit audio, or the volume from the left and right speakers is unbalanced.	The BALANCE control is not set appropriately. The speaker or program source is not connected correctly.	Adjust the BALANCE control. Check and properly connect the equipment.

Troubleshooting Guide

Problem	Cause	Solution
There is an abrupt loss of sound from one or both of the speakers, and the PROTECTOR indicator flickers in the display window.	A short-circuit problem activates the protective circuit.	Turn off the unit, eliminate the short-circuit problem and turn on the power again. If there is no short-circuit problem, consult your nearest Sony dealer.
Sound transmitted from the speakers is reversed.	The speakers are not connected correctly.	Connect the right speaker to the R SPEAKER terminals and the left speaker to the L SPEAKER terminals.
There is lack of bass sound or the instrument position is obscure.	The \oplus/\ominus connection of the speaker is reversed.	Connect the speaker with the correct phase.
Severe hum or noise is heard.	The connecting cords are not shielded type.	Use shielded type cords.
	A transformer, motor, TV or fluorescent light affects the connecting cords.	Place the connecting cords in a location away from a transformer or motor, and at least 3 meters (10 feet) from a TV set or a fluorescent light.
	The audio components are too close to a TV set.	If both are used at the same time, separate the TV from the audio components.
	The unit is not grounded.	Connect the ground wire to the antenna ground terminal.
	The connections are loose.	Make secure connections.
	The plugs and jacks are dirty.	Wipe the plugs and jacks with a cloth lightly dampened with alcohol.
Surround effect cannot be obtained.	The unit is in a wrong mode.	Press CURSOR MODE to set the surround mode.
	The SOUND FIELD circuit is turned off.	Press SOUND FIELD ON/OFF.
The remote commander will not operate.	The batteries are exhausted.	Replace the batteries with new ones.
	The commander head is not pointed toward the unit's front.	Point the commander head toward the receiver.
The equipment cannot be operated.	The mode of the receiver is not same with that of the remote commander.	Press the desired FUNCTION button again.

Specifications

Audio Power Specifications

POWER OUTPUT AND TOTAL HARMONIC DISTORTION

Stereo mode

With 8-ohm load, both channels driven, from 20 - 20,000 Hz, rated 100 watts (STR-D990) or 80 watts (STR-D790) per channel minimum RMS power, with no more than 0.1 % total harmonic distortion from 250 milliwatts to rated output.

Surround mode

	STR-D990	STR-D790
FRONT	65 W + 65 W	80 W + 80 W
CENTER	65 W	20 W
REAR	25 W	20 W

Other Specifications

Dynamic power output		STR-D990: 140 W + 140 W (8 ohms) 190 W + 190 W (4 ohms) STR-D790: 105 W + 105 W (8 ohms) 140 W + 140 W (4 ohms)
Harmonic distortion at rated output		Less than 0.1 %
Intermodulation (IM) distortion at rated output		Less than 0.1 %
Frequency response	PHONO	RIAA equalization curve ± 0.5 dB
	CD, DAT, TAPE 1,2 VIDEO 1,2,3*	10 Hz — 70 kHz ± 1 dB
Residual noise		Less than 70 μ V
Damping factor (8 ohms, at 1kHz)		50
Input sensitivity/impedance	PHONO MM	2.5 mV, 50 kilohms
	DAT, CD, VIDEO 1,2,3* TAPE 1,2	200 mV 50 kilohms
S/N	PHONO MM	87 dB 79 dB** (A, 2.5mV)
	DAT, CD VIDEO 1,2,3* TAPE 1,2	105 dB 85 dB** (A, 200 mV)
Output	DAT OUT, TAPE OUT 1,2 VIDEO 1	200 mV 10 kilohms
	SPEAKERS	Accepts speakers of 8-16 ohms
	HEADPHONES	Accepts headphones of high and low impedance
MUTING	-20dB	
DBFB	+ 10 dB at 70 Hz	
TONE	± 10 dB at 100 Hz and 10 kHz	

* STR-D990 only
** '78IHF

Specifications

FM tuner section

Frequency range	87.5 — 108.0 MHz	
Antenna terminals	300 ohms, balanced 75 ohms, unbalanced	
Sensitivity at 50 dB	18.3 dBf, 4.5 μ V (mono) 38.3 dBf, 45 μ V (stereo)	
Usable sensitivity	11.2 dBf, 2 μ V (IHF)	
S/N	Mono	80 dB
	Stereo	74 dB
Harmonic distortion at 1 kHz	Mono	0.3 %
	Stereo	0.5 %
IM distortion	Mono	0.3 %
	Stereo	0.5 %
Separation	45 dB at 1 kHz	
Frequency response	30 Hz — 15 kHz ± 0.2 dB	
Selectivity	60 dB at 400 kHz	
Capture ratio	1.2 dB	
AM suppression ratio	54 dB	
Image response ratio	70 dB	
IF response ratio	70 dB	
Spurious response ratio	80 dB	
RF intermodulation at 800 kHz	60 dB	
Auto tuning threshold	Low	30 dBf
	High	50 dBf

AM tuner section

Frequency range	530 — 1710 kHz (with 10 kHz interval) 531 — 1710 kHz (with 9 kHz interval) 531 — 1602 kHz (only for STR-D790 U.K. model)
Antenna	Loop antenna
Usable sensitivity	50 dB/m (at 1,000 kHz or 999 kHz)
S/N	54 dB (at 50 mV/m)
Harmonic distortion	0.5% (50 mV/m, 400 Hz)
Selectivity	35 dB (9 kHz), 40 dB (10 kHz)
Auto tuning threshold	55 dB/m

Video section

	STR-D990	STR-D790
Inputs	VIDEO 1,2,3: 1 Vp-p 75 ohms	VIDEO 1,2: 1 Vp-p 75 ohms
Outputs	VIDEO 1, MONITOR: 1 Vp-p 75 ohms	

General

		STR-D990	STR-D790
System	Tuner section	PLL quartz-locked digital synthesizer system	
	Preamplifier section	Low-noise NF type equalizer	
	Power amplifier section	Pure-complimentary SEPP	
Power requirements	120 V AC, 60 Hz U.K. model: 240 VAC, 50/60 Hz		
Power consumption	USA model: 240 W Canada model: 320 VA	USA model: 200 W Canada model: 270 VA	
AC outlets	USA and Canada models: Two switched, total 120 watts U.K. model: One switched, 100 watts max.		
Dimensions	430 x 147.5 x 350 mm (17 x 5 $\frac{7}{8}$ x 13 $\frac{3}{4}$ inches)		
Weight	10.5 kg (23 lb 2 oz)	10.3 kg (22 lb 11 oz)	

Supplied accessories FM ribbon antenna (1)
AM loop antenna (1)
Remote commander (1)
Sony Batteries SUM-3(NS) (2)

Design and specifications are subject to change without notice.

Note

This appliance conforms with EEC Directive 87/308/EEC regarding interference suppression.

Quick Reference

When operate the unit consulting this Quick Reference, make sure that the unit and the various audio/video equipment are properly connected.

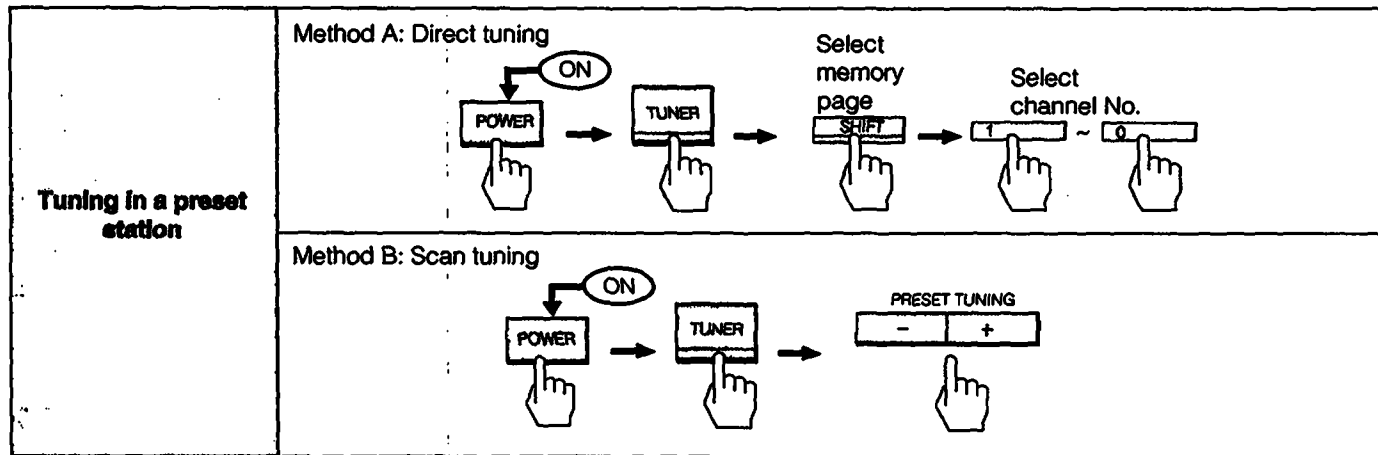
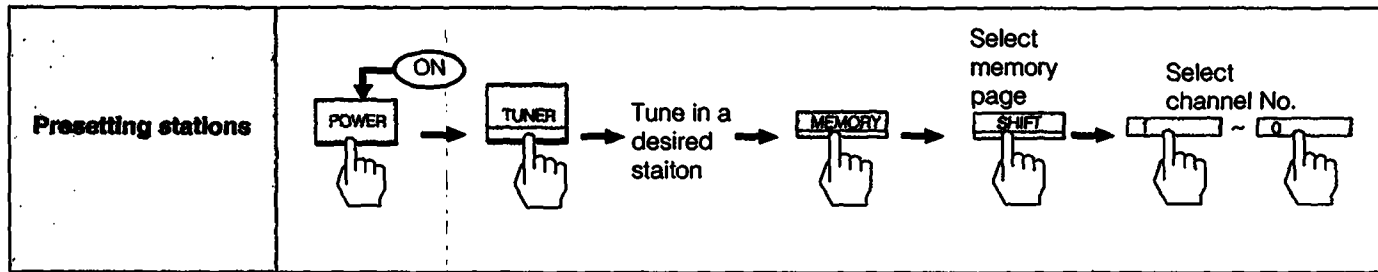
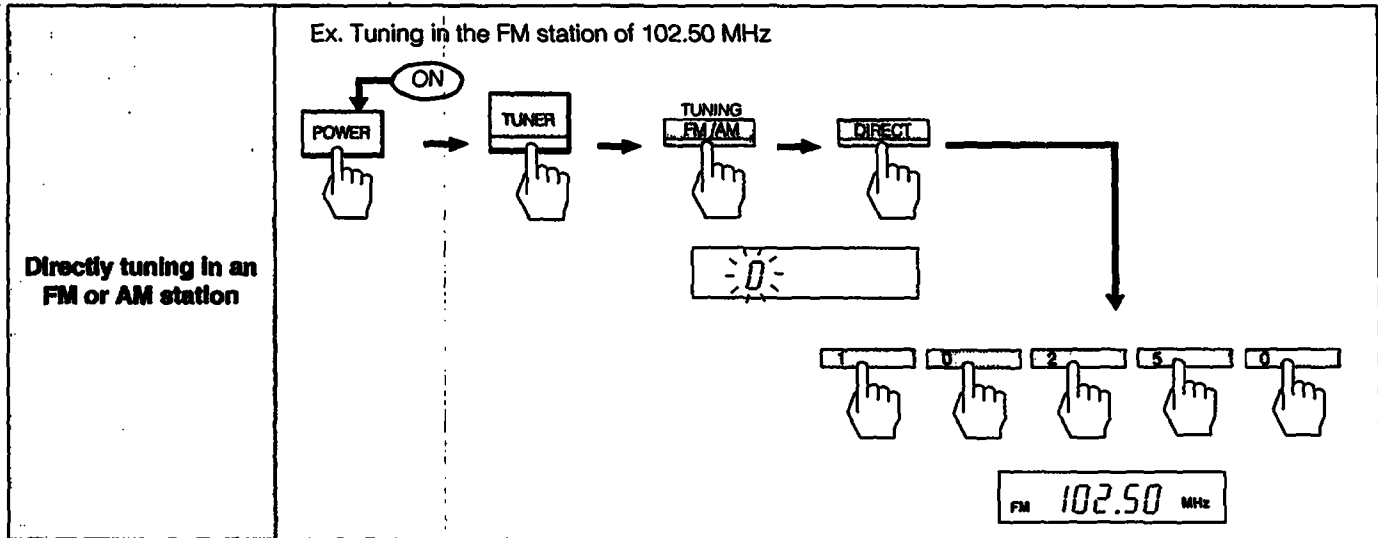



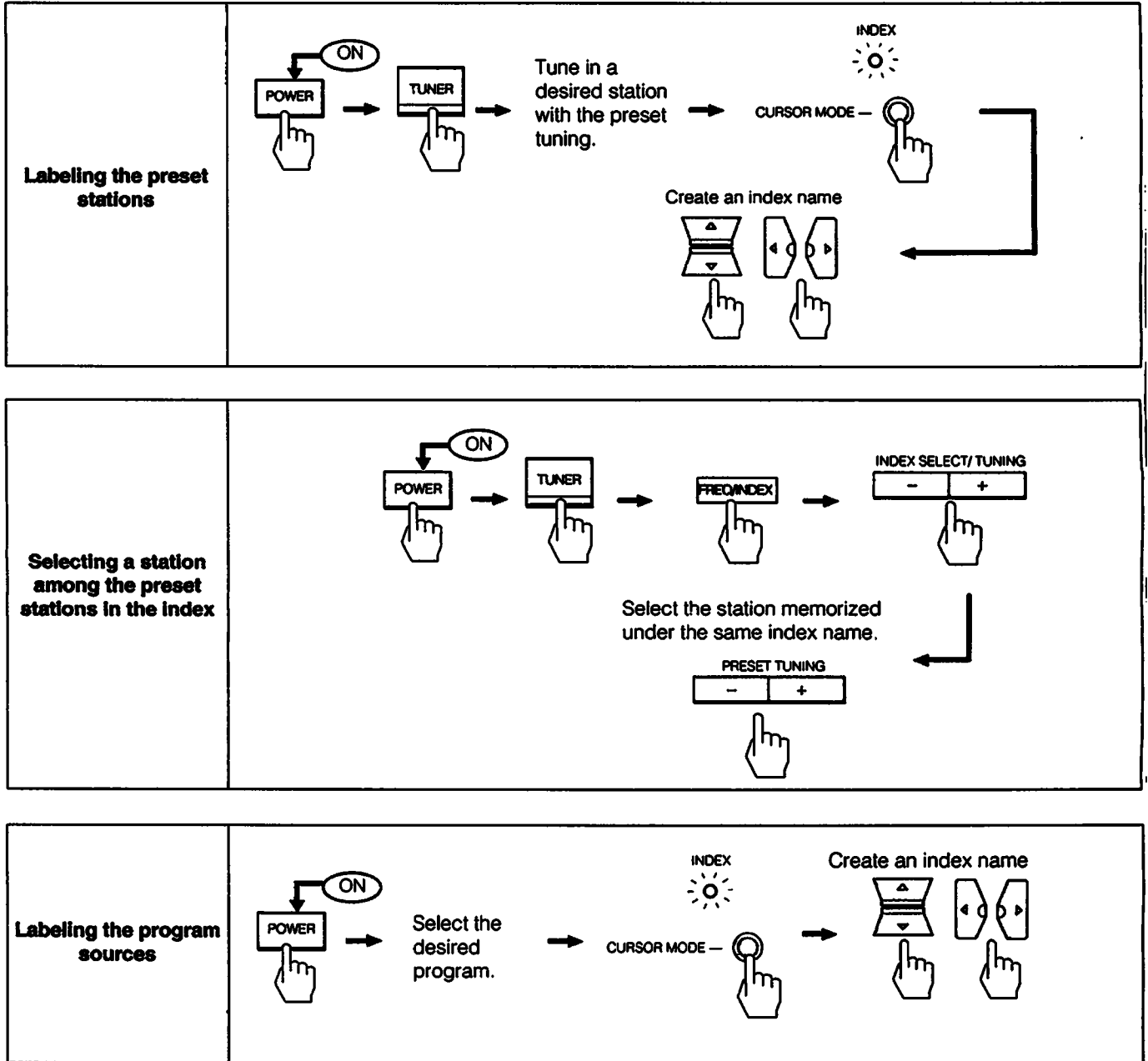



Quick Reference









Adjusting the TONE controls

Select the desired SOUND FIELD program.

CURSOR MODE —  →  →  →  →  → 

Adjusting the surround setting

Select the desired SOUND FIELD program.

CURSOR MODE —  →  →  →  →  → 



Calling up the SOUND FIELD setting

Press the desired SOUND FIELD program.



Linking the SOUND FIELD memory to preset stations

Tune in a station or select the program source to be linked with sound field data.

LINK ON/OFF  →  → 

Quick Reference

Remote Commander Operations

